

fiora | TOUCH
YOUR
BATHROOM

The "Mini" 02

- CATALOGUE -



All fióra

Productos para proyectos integrales de baño
 Prodotti per progetti integrali da bagno
 Products for integral bathroom projects
 Produits pour projets complets de salle de bain
 Produkte für ganzheitliche Badezimmer-Projekte



GAMA DE PRODUCTOS | GAMMA DI PRODOTTI | PRODUCT RANGE | GAMME DE PRODUITS | PRODUKTSORTIMENT

15 Texturas

15 Finiture
 15 Textures
 15 Textures
 15 Strukturen

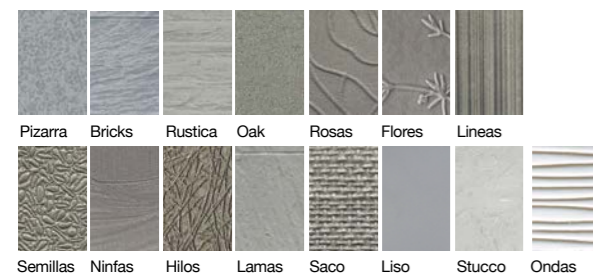

+ Infinidad de Colores

Infinità di colori
 Infinite Colours
 Une Infinité de Couleurs
 Unendlich viele Farben



Plato de Ducha
 Piatto doccia
 Shower Tray
 Receveur de Douche
 Duschböden

Trace **NEW!**
 Privilege
 Silex
 Avant
 Elax
 Essential



Paneles para alicatar
 Pannelli per pareti
 Wall panels
 Panneaux d'habillage
 Rückwände

Skin



Radiadores
 Radiatori
 Radiators
 Radiateurs
 Badheizkörper

Celsius **NEW!**
 Vulcano Electric
 Vulcano Hydro



Muebles de baño
 Mobili da bagno
 Bathroom furniture
 Meubles de salle de bain
 Bandmödel

Making
 Intouch
 Vivaldi



Lavabos & Consolas
 Lavabi & Console
 Wash basins & Consoles
 Vasques & Consoles
 Waschtische & Konsolen

Fontana



Índice Producto

Indice Prodotto
Product Index
Index Produit
Inhoud Product

Platos de Ducha

Piatti Doccia
Shower Trays
Receveurs de Douche
Duschböden

NEW

Trace | P.10

Extraplano
Extrapiano
Extra flat
Extra-plat
Extraflach



Privilege | P.14

Extraplano & Enmarcado a medida
Extrapiano & Bordato su misura
Extra flat & Framed to measure
Extra-plat & Avec cadre sur mesure
Extraflach & Mit Schwallenschutzleiste auf Maß



Silex | P.18

Extraplano, Enmarcado, A medida, Mixto
Extrapiano, Bordato, Su misura, Mixto
Extra flat, Framed, To measure, Mixto
Extra-plat, Avec cadre, Sur mesure, Mixto
Extraflach, Mit Schwallenschutzleiste, Auf Maß, Mixto

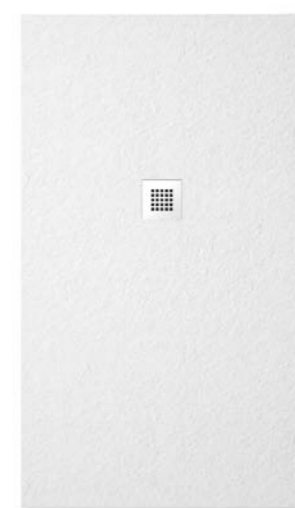

Avant | P.22

Avant
Avant
Avant

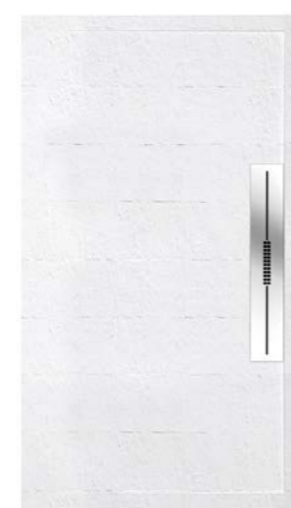

Paneles para alicatar

Pannelli per pareti
Wall panels
Panneaux d'habillage
Rückwände

Skin Panels | P.34



Radiadores

Radiatori
Radiators
Radiateurs
Badheizkörper

NEW

Celsius | P.38



Vulcano Electric | P.42



Vulcano Hidro | P.46



Essential | P.26 Elax | P.30

Essential
Essential
Essential



100% Flexible. Para la ducha de obra
100% Flessibile. Per la doccia in cantiere.
100% Flexible. For the refurbished shower.
100 % Souple. Pour une douche maçonnée.
100% Flexibel. Für die ebenerdige Dusche.

Tea System
Tea System
Tea System

Classic
Classic
Classic

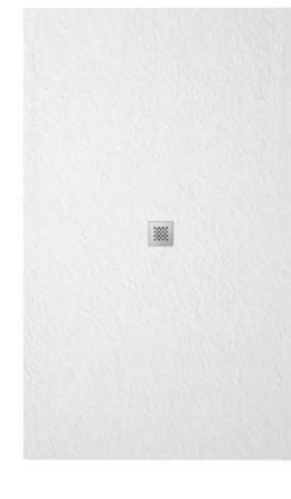
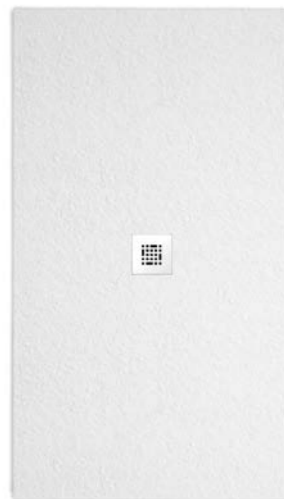

Muebles

Mobili
Furniture
Meubles
Möbel

Making | P.50

OAK NEW



Intouch | P.52



Vivaldi | P.56



Lavabos & Consolas

Lavabi & Console
Wash basins & Consoles
Vasques & Consoles
Handwaschbecken & Waschtische

Fontana | P.60

Consolas Rectas, Curvas, Lavabos sobremesa
Console dritte, Curve, Lavabi soprapiano
Straight Curves Consoles, Table top wash basins
Consoles Droites, Courbes, Vasques à poser
Eckige, Ovale Waschtische, Aufsatzwaschbecken





Cambio de bañera por ducha
Sostituzione della vasca con la doccia
Changing a bathtub for a shower
Remplacement de baignoire par une douche
Duschböden statt Badewanne

Los platos de ducha y los paneles para paredes de Fiora son la mejor solución para los cambios de bañera por ducha. por cuestiones como su instalación y su posibilidad de combinación en texturas y colores.

I piatti doccia e i pannelli per pareti di Fiora sono la migliore soluzione per la sostituzione della vasca con la doccia, sia per quanto riguarda l'installazione che per la loro possibilità di combinazione nelle finiture e nei colori.

Fiora shower trays and wall panels are the best solution for changing a bathtub for a shower, thanks to its installation and the possibility of combining textures and colours.

Les Receveurs de Douche et les Panneaux d'habillage Fiora sont la meilleure solution en cas de remplacement de baignoire par une douche, grâce à leur mode d'installation et leur choix de coordination en textures et couleurs.

Die Duschböden und Rückwände von Fiora sind aufgrund ihrer unkomplizierten Installation und der möglichen Kombination von Strukturen und Farben die beste Lösung eine Badewanne durch einen Duschboden zu ersetzen.

1
 Plato de Ducha
 Piatto doccia
 Shower Tray
 Receveur de Douche
 Duschböden



2
 Paneles para paredes
 Pannelli per pareti
 Wall panels
 Panneaux d'habillage
 Rückwände



Proceso de Instalación | Procedura d'installazione | Installation Process | Installation | Installationsprozess

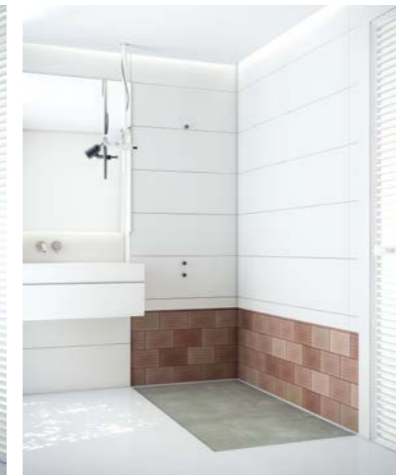

2
 Paneles para paredes
 Pannelli per pareti
 Wall panels
 Panneaux d'habillage
 Rückwände

1
 Plato de Ducha
 Piatti Doccia
 Shower Tray
 Receveur de Douche
 Duschböden

Ventajas
Vantaggi
Advantages
Avantages
Voordelen



2 Paredes
 2 Pareti
 2 Walls
 2 Murs
 2 Wände

3 Paredes
 3 Pareti
 3 Walls
 3 Murs
 3 Wände

> **Rápida Instalación**
 Installazione rapida
 Quick installation
 Rapidité d'installation
 Schnelle Installation

> **Obra mínima**
 Lavori minimi
 Minimal construction work
 Moins de travaux
 Geringer Arbeitsaufwand

> **Sin juntas**
 Assenza di giunzioni
 No joints
 Sans joints
 Ohne Dichtungen

> **Colores&texturas unificados**
 Colori & finiture unificati
 Unified colours&textures
 Couleurs&textures assorties
 Kompatibele Farben&Strukturen



Cambio de bañera por ducha
 Sostituzione della vasca con la doccia
 Changing a bathtub for a shower
 Remplacement de baignoire par une douche
 Duschböden statt Badewanne

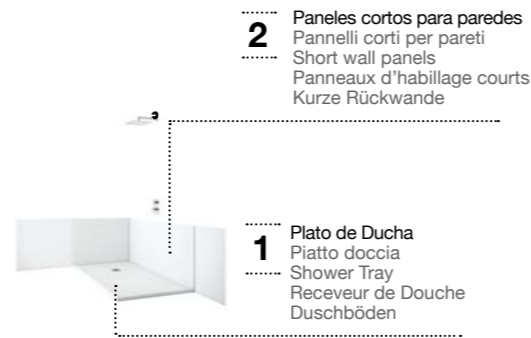

Skin + Platos de Ducha =

Paneles para alicatar
 Pannelli per pareti
 Wall panels
 Panneaux d'habillage
 Rückwände

Plato de Ducha
 Piatto doccia
 Shower Tray
 Receveur de Douche
 Duschböden

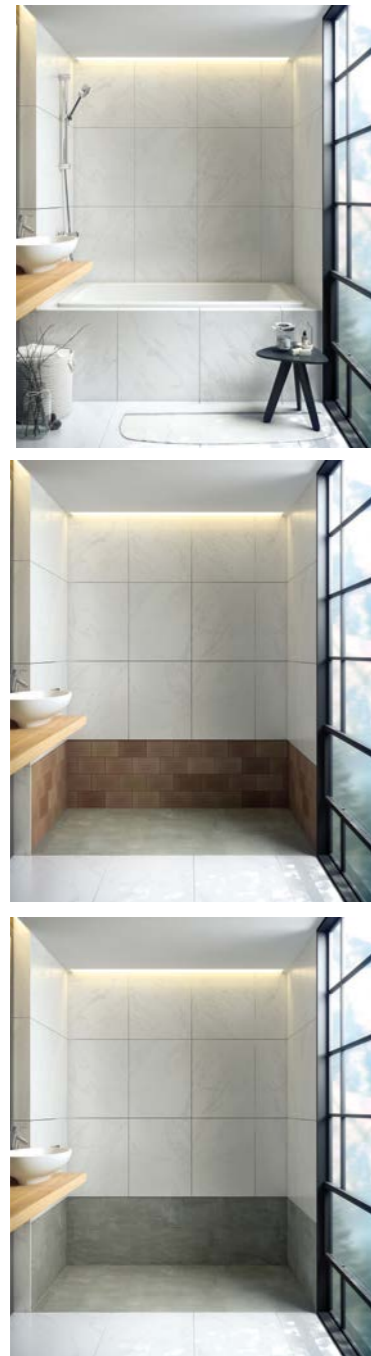

Proceso del cambio
 Fasi della sostituzione
 Changing process
 Étapes de l'installation
 Vervangingsprocedure



Plato de ducha con paneles cortos Skin
 Primo piatto doccia con pannelli corti Skin
 Shower tray with short Skin panels
 Receveur de Douche avec panneaux Skin
 Douchebak met korte Skin panelen



Plato de ducha con paneles Skin
 Primo piatto doccia con pannelli Skin
 Shower tray with Skin panels
 Receveur de Douche avec panneaux Skin
 Douchebak met Skin panelen



Proceso del cambio
 Fasi della sostituzione
 Changing process
 Étapes de l'installation
 Vervangingsprocedure

Platos de Ducha
Piatto doccia
Shower Trays
Receveurs de Douche
Duschböden

Trace ^{NEW}

Extraplano
Extrapiano
Extra flat
Extra-plat
Extraflach



Adaptable a arquitecturas
Adattabile a diverse architetture
Architectural adaptability
Adaptable aux différentes configurations
Anpassbar an alle Konfigurationen

Fabricación a medida
Produzione su misura
Made to measure
Fabrication sur mesure
Maßanfertigung



Adaptable a la arquitectura. Venezia Negro
Adattabile a diverse architetture. Venezia Negro
Adaptable to architecture. Venezia Negro
Adaptable aux différentes configurations. Venezia Negro
Anpassbar an alle Konfigurationen. Venezia Negro



Adaptable a la arquitectura. Saco Bone
Adattabile a diverse architetture. Saco Bone
Adaptable to architecture. Saco Bone
Adaptable aux différentes configurations. Saco Bone
Anpassbar an alle Konfigurationen. Saco Bone



Trace ^{NEW}

Información Técnica | Scheda tecnica | Technical Information | Informations Techniques | Technische Daten

EXTRAPLANO | EXTRAPIANO | EXTRA FLAT | EXTRA-PLAT | EXTRAFLACH



Adaptable a arquitecturas | Adattabile a diverse architetture | Architectural adaptability | Adaptable aux différentes configurations | Anpassbar an alle Konfigurationen

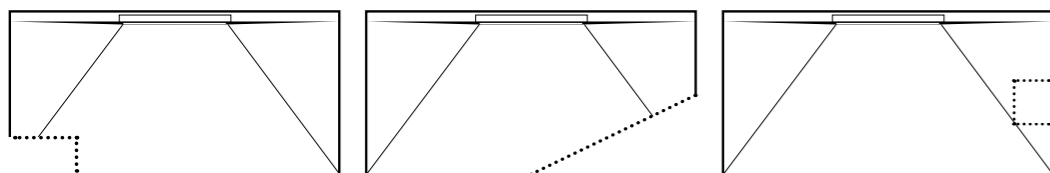

Tapa | Copertura | Top | Couvercle | Oben



Sifons | Sifoni | Wastes | Siphons | Abläufe



SIFÓN L-DRAIN

Salida horizontal
Uscita orizzontale
Horizontal outlet
Sortie horizontale
Waagerechter Ablauf

*** Sifón enviado por defecto**
Sifone posto di default
Waste fitted by default
Siphon fourni par défaut
Standard-beipack

Texturas & Colores | Finiture & Colori | Textures & Colours | Textures & Couleurs | Strukturen & Farben

PIZARRA



Colores Sólidos | Colori a tinta unita | Couleurs Uniformes | Grundfarben



0T Blanco Roto 0P Blanco Total 18T Crema 33T Wengué 31T Gris 22T Negro 36T Capuccino 37T Cenere 40T Bone

NEW

VENEZIA



0T Blanco Roto 0P Blanco Total 18T Crema 33T Wengué 31T Gris 22T Negro 36T Capuccino 37T Cenere 40T Bone

NEW

SACO



0T Blanco Roto 0P Blanco Total 18T Crema 33T Wengué 31T Gris 22T Negro 36T Capuccino 37T Cenere 40T Bone

Platos de Ducha
Piatto doccia
Shower Trays
Receveurs de Douche
Duschböden

Privilege

Extraplano & Enmarchado a medida
Extrapiano & Bordato su misura
Extra flat & Framed to measure
Extra-plat & Avec cadre sur mesure
Extraflach & Mit Schwallenschutzleiste auf Maß



Adaptable a arquitecturas
Adattabile a diverse architetture
Architectural adaptability
Adaptable aux différentes configurations
Anpassbar an alle Konfigurationen

Fabricación a medida
Produzione su misura
Made to measure
Fabrication sur mesure
Maßanfertigung



Adaptable a la arquitectura. Pizarra Negro
Adattabile a diverse architetture. Pizarra Negro
Adaptable to architecture. Pizarra Negro
Adaptable aux différentes configurations. Pizarra Negro
Anpassbar an alle Konfigurationen. Pizarra Negro



Adaptable a la arquitectura. Pizarra Blanco Nature
Adattabile a diverse architetture. Pizarra Blanco Nature
Adaptable to architecture. Pizarra Blanco Nature
Adaptable aux différentes configurations. Pizarra Blanco Nature
Anpassbar an alle Konfigurationen. Pizarra Blanco Nature



Privilege

Información Técnica | Scheda tecnica | Technical Information | Informations Techniques | Technische Daten

EXTRAPLANO | EXTRAPIANO | EXTRA FLAT | EXTRA-PLAT | EXTRAFLACH

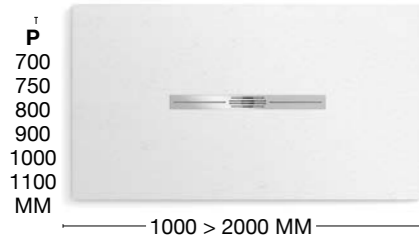

P 700/750/800/900/1000/1100
L 1000/1200/1400/1600/1800/2000
*** OPTION ***
Fabricación a medida
Produzione su misura
Made to measure
Fabriqué sur mesure
Maßanfertigung

ENMARCADO | BORDATO | FRAMED | CADRE | MIT SCHWALLSCHUTZLEISTE

A medida | Made-to-measure | Sur mesure | Op maat

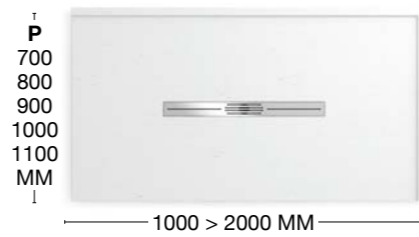

A 700/750/800/900/1000/1100
L 1000/1200/1400/1600/1800/2000
*** OPTION ***
Fabricación a medida
Produzione su misura
Made to measure
Fabriqué sur mesure
Maßanfertigung

Canal para mamparas | Canale per box | Channel for partitions
Rainure pour cloisons | Einlass für Abtrennung



Adaptable a arquitecturas | Adattabile a diverse architetture | Architectural adaptability
Adaptable aux différentes configurations | Anpassbar an alle Konfigurationen

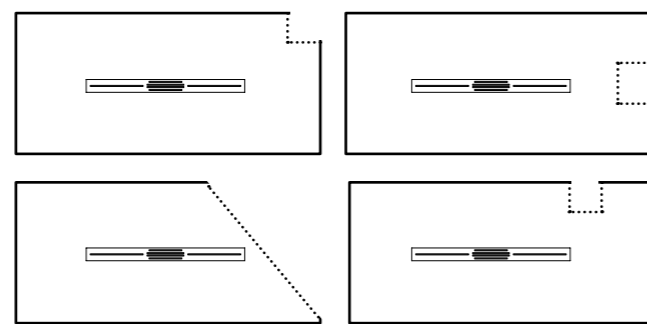

Rejilla | Griglia | Grate | Grille | Ablaufrinne

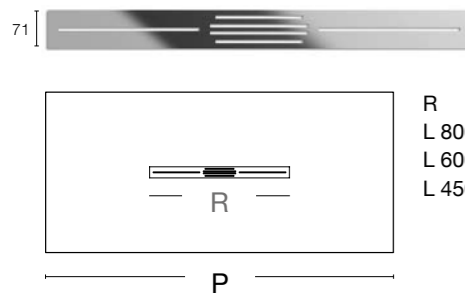

Lacada | Lacatta | Lacquered | Laquée | Beschichtet

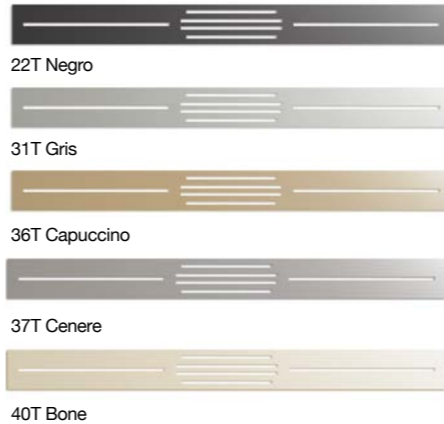
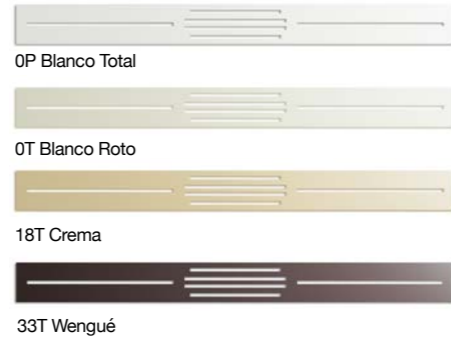

Sifons | Sifoni | Wastes | Siphons | Abläufe

SIFÓN D52

Salida horizontal
Uscita orizzontale
Horizontal outlet
Sortie horizontale
Waagerechter Ablauf

viega

*** Sifón enviado por defecto**
Sifone posto di default
Waste fitted by default
Siphon fourni par défaut
Standard-beipack



SIFÓN D52 VERTICAL

Salida vertical
Uscita verticale
Vertical outlet
Sortie verticale
Senkrechter Ablauf

viega

*** Opcional**
Opzionale
Optional
En option
Optional

Texturas & Colores | Finiture & Colori | Textures & Colours | Textures & Couleurs | Strukturen & Farben

PIZARRA

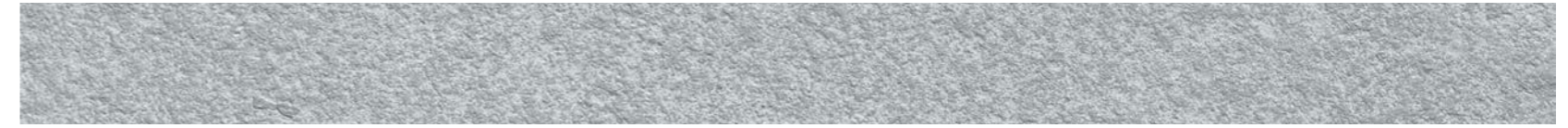

Colores Sólidos | Colori a tinta unita | Solid Colours | Couleurs Uniformes | Grundfarben



Colores Nature | Colori Nature | Nature Colours | Couleurs Nature | Patinierte Farben

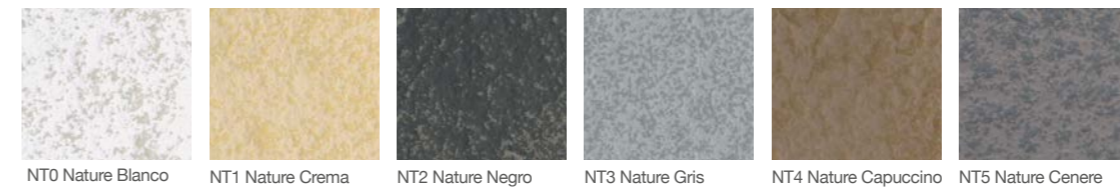

BRICKS



Colores Sólidos | Colori a tinta unita | Solid Colours | Couleurs Uniformes | Grundfarben



Colores Nature | Colori Nature | Nature Colours | Couleurs Nature | Patinierte Farben



LISO



Platos de Ducha
Piatto doccia
Shower Trays
Receveurs de Douche
Duschböden

Silex

Extraplano, Enmarcado, A medida, Mixto
Extrapiano, Bordato, Su misure, Mixto
Extra flat, Framed, To measure, Mixto
Extra-plat, Avec cadre, Sur mesure, Mixto
Extraflach, Mit Schwallschutzleiste, Auf Maß, Mixto



Enmarcado Pizarra Blanca
Bordado Pizarra Blanca
Framed Pizarra Blanca
Avec cadre Pizarra Blanca
Mit Schwallschutzleiste Pizarra Blanca



Silex Mixto Pizarra Blanca
Silex Mixto Pizarra Blanca
Silex Mixto Pizarra Blanca
Silex Mixto Pizarra Blanca
Silex Mixto Pizarra Blanca



Zona de secado
Zona di asciugatura
Drying area
Zone de séchage
Trockenbereich



Plato de ducha Angular
Piatto doccia angolare
Quadrant shower tray
Receveur de Douche d'Angle
Viertelkreis Duschböden



Enmarcado a medida y adaptado a arquitectura
Bordato su misura e adattato all'architettura
Framed to measure and adapted to architecture
Cadre sur mesure et adapté à la configuration
Mit Schwallschutzleiste auf Maß und an die konfiguration angepasst



Silex

Información Técnica | Scheda tecnica | Technical Information | Informations Techniques | Technische Daten

EXTRAPLANO | EXTRAPIANO | EXTRA FLAT | EXTRA-PLAT | EXTRAFLACH

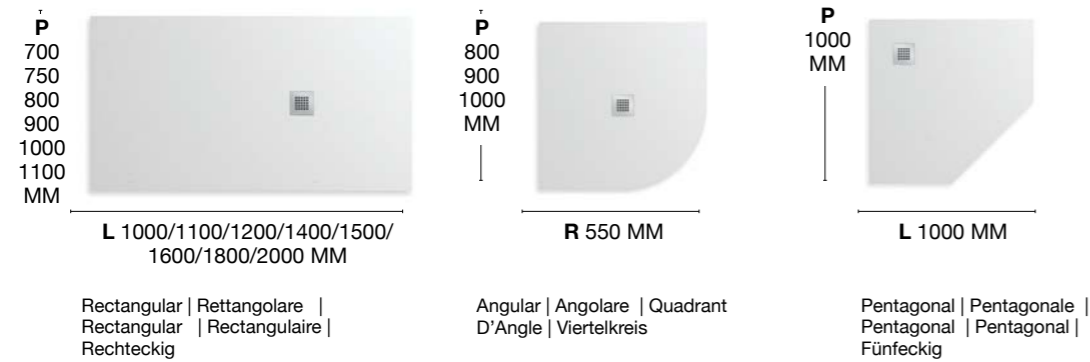

ENMARCADO | BORDATO | FRAMED | CADRÉ | MIT SCHWALLSCHUTZLEISTE

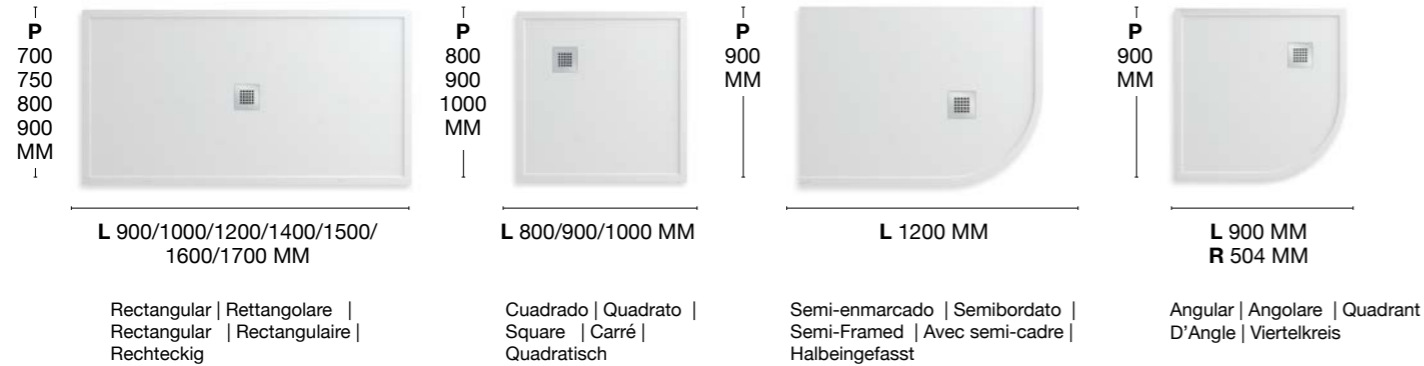

MIXTO | MIXTO | MIXTO | MIXTO | MIXTO



ENMARCADO A MEDIDA | BORDATO SU MISURA | FRAMED TO MEASURE | AVEC CADRE SUR MESURE | MIT SCHWALLSCHUTZLEISTE



Canal para mamparas
Canale per box
Channel for partitions
Rainure pour cloisons
Einlass für Abtrennung



Adaptable a arquitecturas | Adattabile a diverse architetture | Architectural adaptability | Adaptable aux différentes configurations | Anpassbar an alle Konfigurationen

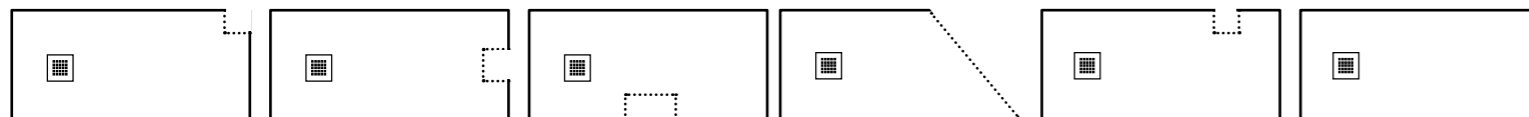

Sifons | Sifoni | Wastes | Siphons | Abläufe



SIFÓN (ESTÁNDAR)

Salida horizontal
Uscita orizzontale
Horizontal outlet
Sortie horizontale
Waagerechter

SIFÓN VERTICAL

Salida vertical
Uscita verticale
Vertical outlet
Sortie verticale
Senkrechter

SIFÓN REDUCIDO

Sifón reducido salida horizontal
Sifone ridotto uscita orizzontale
Small waste horizontal outlet
Siphon raccourci sortie horizontale
Siphon mit reduzierter Höhe und reduzierter Ablauf

SIFÓN PLUS

Plus salida horizontal
Plus uscita orizzontale
Plus horizontal outlet
Plus sortie horizontale
Ablauf für grossere Abflussmengen

Texturas & Colores | Finiture & Colori | Textures & Colours | Textures & Couleurs | Strukturen & Farben

PIZARRA

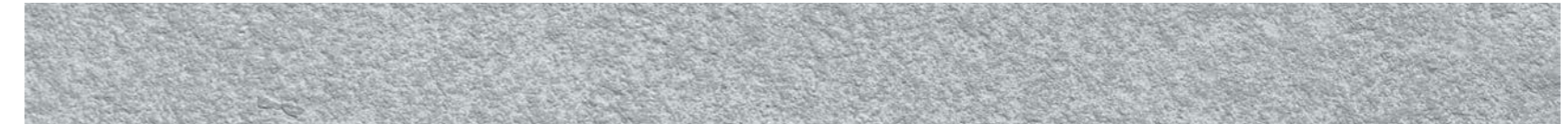

Colores Sólidos | Colori a tinta unita | Solid Colours | Couleurs Uniformes | Grundfarben



Colores Nature | Colori Nature | Nature Colours | Couleurs Nature | Patinierte Farben

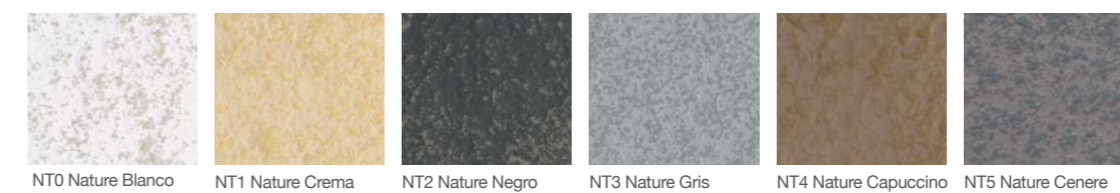

LISO



Platos de Ducha
Piatto doccia
Shower Trays
Receveurs de Douche
Duschböden

Avant



Posibilidad de adaptación a arquitecturas
Possibilità di produzione su misura adattabile a diverse architetture.
Possibility of custom manufacturing
Architectural adaptability.
Possibilité de fabrication sur mesure.
Adaptable aux différentes configurations.
Maßanfertigung möglich, anpassbar an alle Konfigurationen

Rejilla Lacada blanca
Griglia laccata bianca
White Lacquer grate
Grille Laquée en blanc
Weiß beschichtet Ablaufrinne



Avant

Información Técnica | Scheda tecnica | Technical Information | Informations Techniques | Technische Daten

Dimensiones | Dimensioni | Dimensions | Dimensions | Maße

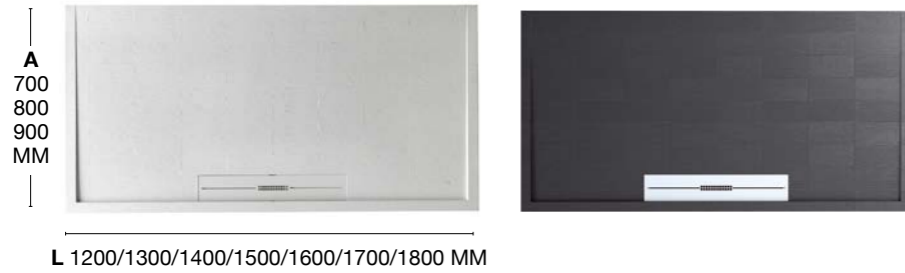

Rejilla | Griglia | Grate | Grille | Abflurinne



Lacada | Lacquered | Laquée | Gelakt

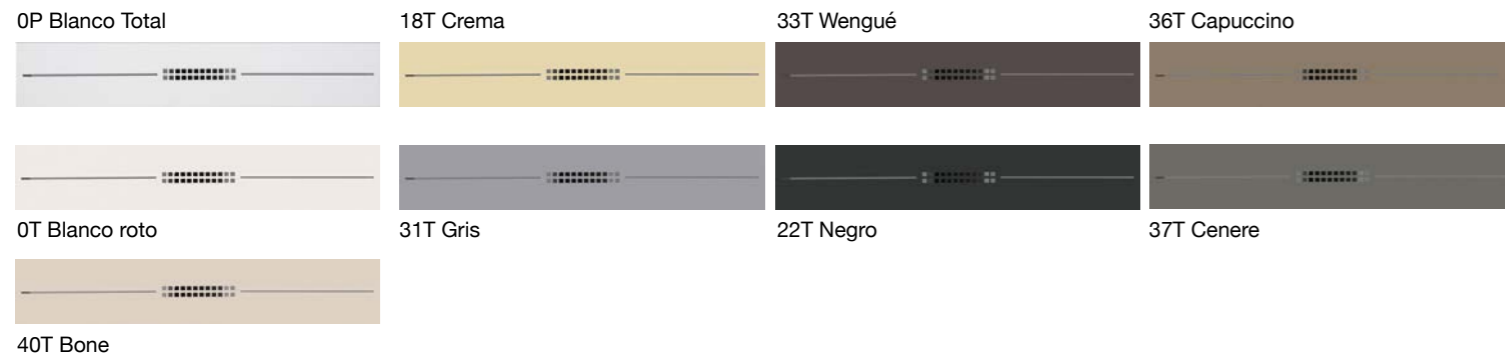

Sifons | Sifoni | Wastes | Siphons | Abläufe



SIFÓN (ESTÁNDAR)

Salida horizontal
Uscita orizzontale
Horizontal outlet
Sortie horizontale
Waagerechter

SIFÓN VERTICAL

Salida vertical
Uscita verticale
Vertical outlet
Sortie verticale
Senkrechter

SIFÓN REDUCIDO

Sifón reducido salida horizontal
Sifone ridotto uscita orizzontale
Small waste horizontal outlet
Siphon raccourci sortie horizontale
Siphon mit reduzierter Höhe und reduzierter Ablauf

SIFÓN PLUS

Plus salida horizontal
Plus uscita orizzontale
Plus horizontal outlet
Plus sortie horizontale
Ablauf für grossere Abflussmengen

Texturas & Colores | Finiture & Colori | Textures & Colours | Textures & Couleurs | Strukturen & Farben

PIZARRA



Colores Sólidos | Colori a tinta unita | Solid Colours | Couleurs Uniformes | Grundfarben



Colores Nature | Colori Nature | Nature Colours | Couleurs Nature | Patinierte Farben

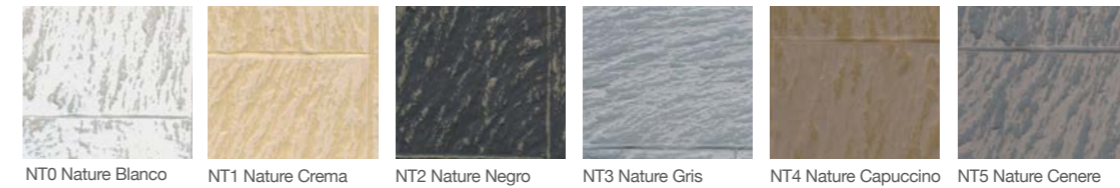

Platos de Ducha
Piatto doccia
Shower Trays
Receveurs de Douche
Duschböden

Essential

El mejor precio con la calidad Fiora.
Il miglior prezzo senza perdere la qualità Fiora.
The best price without losing Fiora quality.
Le meilleur prix pour la même qualité Fiora.
Bester Preis, ohne auf die Fiora-Qualität zu verzichten.



Cambio de bañera por ducha
Sostituzione della vasca con la doccia
Changing a bathtub for a shower
Remplacement de baignoire par une douche
Duschböden statt Badewanne

Essential + Skin =

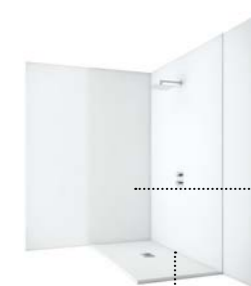

2 Paneles para paredes
Pannelli per pareti
Wall panels
Panneaux d'habillage
Rückwände

1 Plato de Ducha
Piatto Doccia
Shower Tray
Receveur de Douche
Duschböden



Son fácilmente adaptables en obra.
Sono facilmente adattabili in cantiere.
They are easily adapted during construction.
Adaptable durant l'installation.
Einfach Vorort zuschneidbar.

Pizarra Blanca



Dimensiones | Dimensioni | Dimensions | Dimensions | Maße

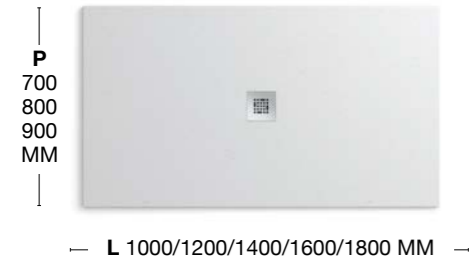

Rejilla | Griglia | Grate | Grille | Ablaufrinne

SIFÓN ESSENTIAL

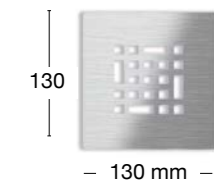

Salida horizontal
Uscita orizzontale
Horizontal outlet
Sortie horizontale
Waagerechter Ablauf

* Sifón enviado por defecto
Sifone inviato in dotazione
Waste sent by default
Siphon envoyé par défaut
Standardmäßig gelieferter Ablauf

Sifons | Sifoni | Wastes | Siphons | Abläufe



SIFÓN (ESTÁNDAR)

Salida horizontal
Uscita orizzontale
Horizontal outlet
Sortie horizontale
Waagerechter



SIFÓN VERTICAL

Salida vertical
Uscita verticale
Vertical outlet
Sortie verticale
Senkrechter



SIFÓN REDUCIDO

Sifón reducido salida horizontal
Sifone ridotto uscita orizzontale
Small waste horizontal outlet
Siphon raccourci sortie horizontale
Siphon mit reduzierter Höhe und reduzierter Ablauf



SIFÓN PLUS

Plus salida horizontal
Plus uscita orizzontale
Plus horizontal outlet
Plus sortie horizontale
Ablauf für grossere Abflussmengen

- > Los platos Essential se envían siempre con el sifón Essential.
- > Hay disponibles otros 4 tipos de sifones: estándar, vertical, reducido y plus.
- > Sifons Viega.

- > I piatti Essential si inviano sempre con il sifone Essential.
- > Sono disponibili altri 4 tipi di sifoni: standard, verticale, ridotto e plus.
- > Sifoni Viega

- > Essential trays are always sent with the Essential waste.
- > There are 4 other types of waste available: standard, vertical, reduced and plus.
- > Viega wastes

- > Les plateaux Essential sont toujours livrés avec le siphon Essential.
- > 4 types de siphons sont disponibles : standard, vertical, raccourci et plus.
- > Siphons Viega.

- > Die Duschböden Essential werden immer mit dem Ablauf Essential zusammen versendet.
- > Außerdem gibt es 4 andere Ablauftypen: Standard, Senkrecht, mit reduzierter Höhe und Plus.
- > Abläufe Viega



Texturas & Colores | Finiture & Colori | Textures & Colours | Textures & Couleurs | Strukturen & Farben

PIZARRA



OT Blanco Roto OP Blanco Total 18T Crema 33T Wengué 31T Gris 22T Negro 36T Capuccino 37T Cenere 40T Bone

Sistema de Embalaje "easy" | Sistema di Imballaggio "easy" | "Easy" packaging system | Système de Conditionnement « easy » | Verpackungssystem "easy"



"easy packaging"
Embalaje diseñado con asas para transportar el plato de ducha con facilidad
Imballaggio progettato con maniglie per trasportare l'imballo della doccia con facilità
Packaging designed with handles to easily transport the shower tray
Emballage conçu avec des poignées pour transporter le Receveur de Douche facilement
Verpackung mit Tragegriffe für den einfachen Transport des Duschbodens

Asas
Handles
Poignées
Handvaten

Platos de Ducha
Piatto doccia
Shower Trays
Receveurs de Douche
Duschböden

Elax

100% Flexible. Para la ducha de obra
100% Flessibile. Per la doccia in cantiere.
100% Flexible. For the refurbished shower.

100 % Souple. Pour une douche maçonnée.
100% Flexibel. Für die ebenerdige Dusche.



TEA System®



Canaleta transversal inox
Canalina trasversale inox
Stainless steel transversal linear drain
Caniveau transversale inox
Querverlaufende Abflussrinne Edelstahl



Elax con canaleta en acabado Elaxpol®
Elax con canalina in finitura Elaxpol®
Elax with linear drain in Elaxpol® finish
Elax avec Caniveau en finition Elaxpol®
Elax mit Abflussrinne mit Finish Elaxpol®

CLASSIC System®



Formas irregulares Pizarra Gris
Forme irregolari Pizarra Gris
Irregular shapes Pizarra Gris
Formes irrégulières Pizarra Gris
Vielfältige Formen Pizarra Gris



Formas circulares Pizarra Negro
Forme circolari Pizarra Negro
Circular shapes Pizarra Negro
Formes circulaires Pizarra Negro
Runde Formen Pizarra Negro



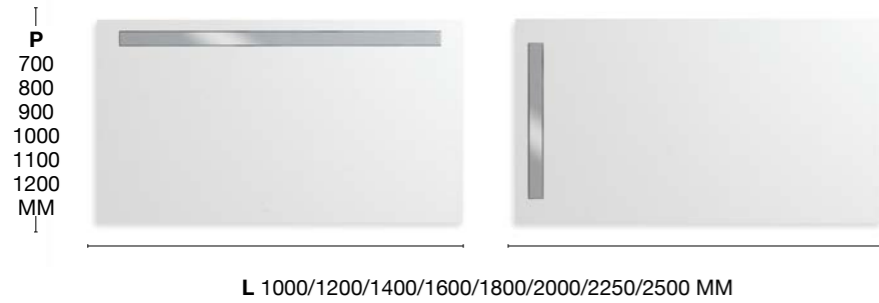

TEA System®

L 1000/1200/1400/1600/1800/2000/2250/2500 MM

Canaleta | Canalina | Linear drain | Conduite d'écoulement | Abflusrinne

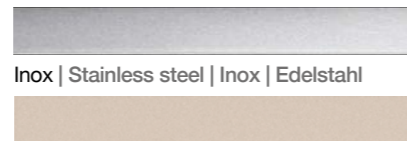

Inox | Stainless steel | Inox | Edelstahl

Elaxpol®



Canaleta en inox o Silexpol® y longitudinal o transversal
Canalina in inox o Silexpol® e longitudinale o trasversale
Linear drain in stainless steel or Silexpol® and longitudinal or transversal
Caniveau en inox ou Silexpol® et longitudinale ou trasversale
Abflusrinne Edelstahl oder Silexpol® und längs-oder querverlaufende

- | | | | |
|--|---|---|---|
| 01. Embellecedor Elaxpol
Coperchio Elaxpol
Elaxpol trim
Enjoliveur Elaxpol
Deko-Element Elaxpol | 02. Embellecedor inox
Canalina con 1 scarico
Stainless steel trim
Enjoliveur inox
Deko-Element Edelstahl | 03. Canaleta
Canalina
Linear drain
Conduite d'écoulement
Abflusrinne | 04. Sifón
Sifone
Waste
Siphon
Ablauf |
|--|---|---|---|

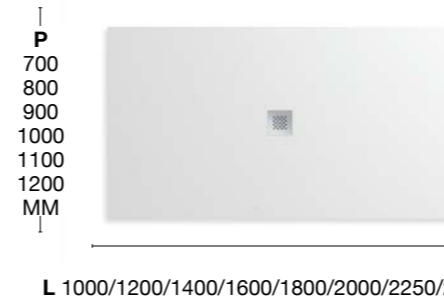

CLASSIC System®

L 1000/1200/1400/1600/1800/2000/2250/2500 MM

Sifons | Sifoni | Wastes | Siphons | Abläufe



CLASSIC SYSTEM 02

Sifón salida horizontal
Sifone uscita orizzontale
Small waste horizontal outlet
Siphon sortie horizontale
Waagerechter Ablauf

Rejilla | Griglia | Grate | Grille | Ablaufrinne



Rejilla Inox
Griglia Inox
Stainless steel grate
Grille Inox
Gitter Edelstahl

Sección sifón interior
Sifone sezione interna
Interior section waste
Section intérieure du siphon
Bereich Ablauf innen

Texturas & Colores | Finiture & Colori | Textures & Colours | Textures & Couleurs | Strukturen & Farben

PIZARRA



0T Blanco Roto 0P Blanco Total 18T Crema 33T Wengué 31T Gris 22T Negro 36T Capuccino 37T Cenere 40T Bone



- 01.** Sección canaleta
Sezione canalina
Linear drain section
Section de la conduite d'écoulement
Bereich der Abflusrinne
- 02.** Canaleta con 1 desagüe
Canalina con 1 scarico
Linear drain with 1 drain
Caniveau1 évacuation
Abflusrinne mit 1 Ablauf
- 03.** Canaleta con 2 desagües
Canalina con 2 scarichi
Linear drain with 2 drains
Caniveau2 évacuations
Abflusrinne mit 2 Abläufen

Paneles para alicatar
 Pannelli per pareti
 Wall panels
 Panneaux d'habillage
 Rückwände

Skin Panels

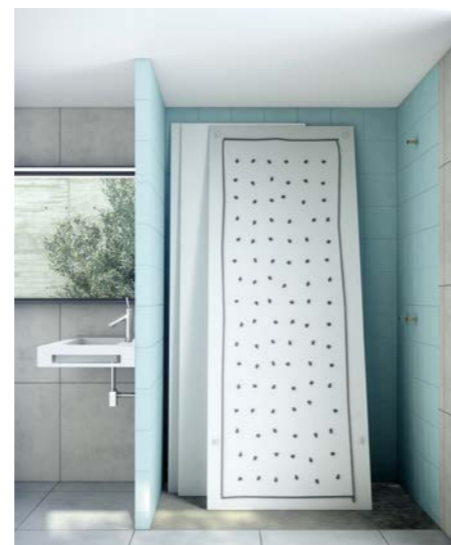

Ducha antigua
 Doccia vecchia
 Old shower
 Ancienne douche
 Dusche vorher

Colocación plato y paneles
 Installazione piatto e pannelli
 Fitting the tray and panels
 Mise en place plateau et panneaux
 Installation von Duschboden und Rückwände



> 2400 MM

L 700/800/900/1000 MM

**fiora
 BOX**

VENTAJAS | VANTAGGI | ADVANTAGES | AVANTAGES | VORTEILE



2 Paredes
 2 Pareti
 2 Walls
 2 Murs
 2 Wände



3 Paredes
 3 Pareti
 3 Walls
 3 Murs
 3 Wände

> **Rápida Instalación**
 Installazione rapida
 Quick installation
 Rapidité d'installation
 Schnelle Installation

> **Obra mínima**
 Lavori minimi
 Minimal construction work
 Moins de travaux
 Wenig Arbeitsaufwand

> **Colores & texturas para decorar**
 Colors & Textures to decorate
 Colours & textures for decorating
 Couleurs & textures pour décorer
 Farben & Strukturen als Dekor



1. Sobre baldosa
 Su piastrella
 On tiles
 Sur carrelage
 Auf Wandfliesen



2. Sobre pared nueva
 Su parete nuova
 On a new wall
 Mur neuf
 Auf Neubau Wanel



Skin Panels

Información Técnica | Scheda tecnica | Technical Information | Informations Techniques | Technische Daten

Dimensiones | Dimensioni | Dimensions | Dimensions | Maße

2200 > 2400 MM

700/750/800/900/1000 MM

Click para instalar
Click per installare
Click to install
Installation en un clic
Nut-feder Verbindung

Sistema de colocación sobre baldosa
Sistema di posizionamento su piastrelle
System for installing on tiles
Système d'installation sur carrelage
Verklebung auf Wandfliesen

Video Rehabilitación | Video ristrutturazione | Refurbishment video
Vidéo Rénovation | Video Sanierung



Video Instalación | Video ristrutturazione | Installation video | Vidéo
Rénovation | Video Installation



www.youtube.es/fiora

Texturas & Colores | Finiture & Colori | Textures & Colours | Textures & Couleurs | Strukturen & Farben

OAK



NT10 Nature Blanco K NT12 Nature Crema K NT13 Nature Plata K NT11 Nature Champán K

ROSAS

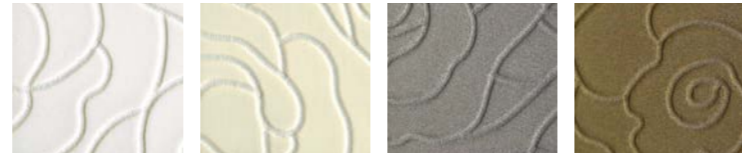
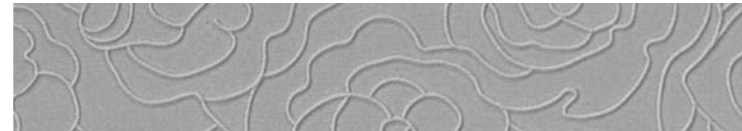

K0 Blanco K K2 Crema K K3 Plata K K1 Champán K

LISO



K0 Blanco K K2 Crema K K3 Plata K K1 Champán K

LINEAS

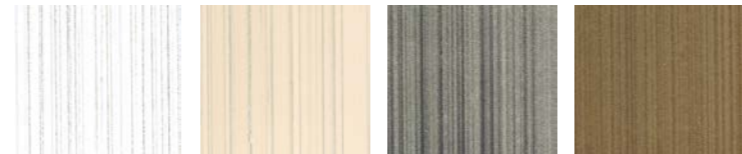
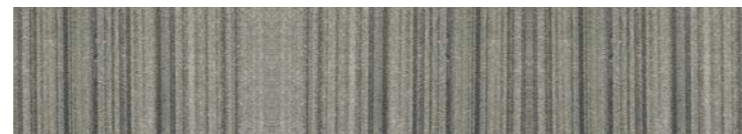

K0 Blanco K K2 Crema K K3 Plata K K1 Champán K

NINFA



K0 Blanco K K2 Crema K K3 Plata K K1 Champán K

SACO

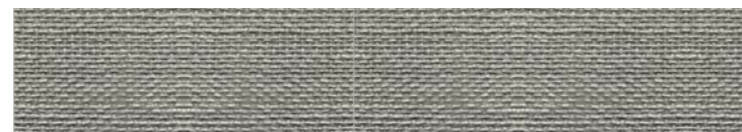

K0 Blanco K K4 Tostado K K3 Plata K K1 Champán K

Texturas & Colores | Finiture & Colori | Textures & Colours | Textures & Couleurs | Strukturen & Farben

PIZARRA

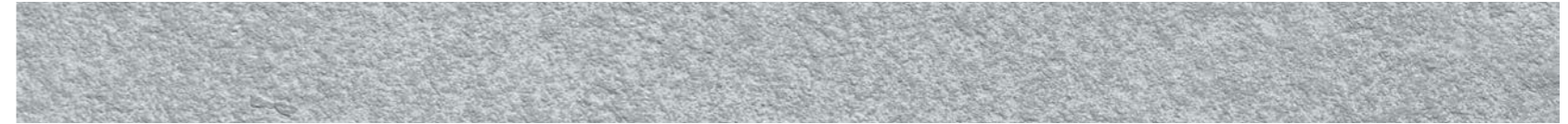

Colores Sólidos | Colori a tinta unita | Solid Colours | Couleurs Uniformes | Grundfarben



0T Blanco Roto 0P Blanco Total 18T Crema 33T Wengué 31T Gris 22T Negro 36T Capuccino 37T Cenere 40T Bone

Colores Nature | Colori Nature | Nature Colours | Couleurs Nature | Patinierte Farben

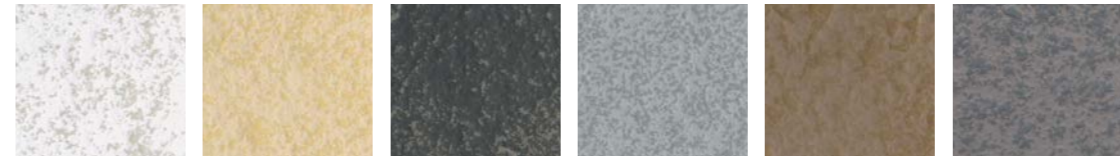

NT0 Nature Blanco NT1 Nature Crema NT2 Nature Negro NT3 Nature Gris NT4 Nature Capuccino NT5 Nature Cenere

LAMAS



Colores Sólidos | Colori a tinta unita | Solid Colours | Couleurs Uniformes | Grundfarben



0T Blanco Roto 0P Blanco Total 18T Crema 33T Wengué 31T Gris 22T Negro 36T Capuccino 37T Cenere 40T Bone

Colores Nature | Colori Nature | Nature Colours | Couleurs Nature | Patinierte Farben

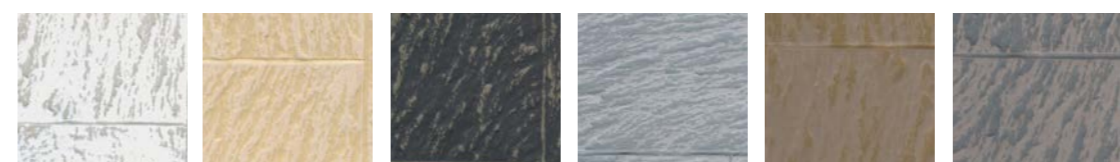

NT0 Nature Blanco NT1 Nature Crema NT2 Nature Negro NT3 Nature Gris NT4 Nature Capuccino NT5 Nature Cenere

STUCCO

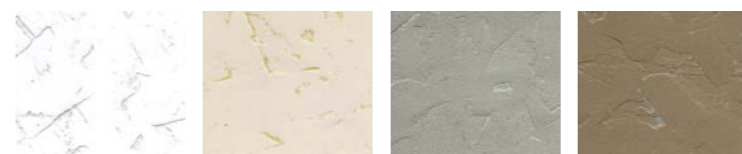

NT10 Nature Blanco K NT12 Nature Crema K NT13 Nature Plata K NT11 Nature Champán K

RUSTICA Colores Sólidos | Colori a tinta unita | Solid Colours | Couleurs Uniformes | Grundfarben

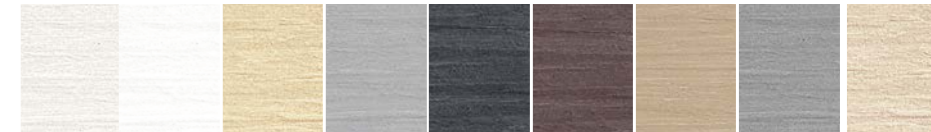

0T Blanco Roto 0P Blanco Total 18T Crema 31T Gris 22T Negro 33T Wengué 36T Capuccino 37T Cenere 40T Bone

RUSTICA Colores Nature | Colori Nature | Nature Colours | Couleurs Nature | Patinierte Farben

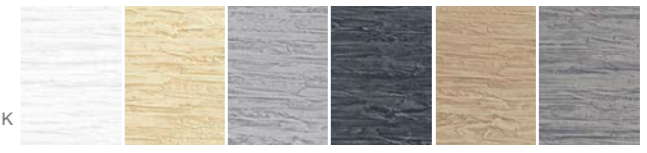

NT0 Nature Blanco NT1 Nature Crema NT3 Nature Gris NT2 Nature Negro NT4 Nature Capuccino NT5 Nature Cenere

Radiadores
Radiatori
Radiators
Radiateurs
Badheizkörper

Celsius **NEW**

Radiadores hidráulicos con sistema de instalación tradicional
Radiatori idraulici con sistema di installazione tradizionale
Water radiators with traditional installation system
Radiateurs hydraulique avec système d'installation traditionnel
Hydraulische-Badheizkörper mit traditionellem Installationssystem



Radiador Celsius Baño 1,50 Pizarra Nature Gris
Radiatori Celsius Bagno 1.50 Pizarra Nature Gris
1.50 Celsius Bathroom Radiator Pizarra Nature Gris
Radiateur Celsius Bain 1,50 Pizarra Nature Gris
Celsius Badheizkörper 1,50 Pizarra Nature Gris

Detalle toallero
Particolare portasciugamani
Towel holder detail
Détail porte-serviettes
Handtuchhalter Detail



Celsius

Información Técnica | Scheda tecnica | Technical Information | Informations Techniques | Technische Daten

Dimensiones | Dimensoni | Dimensions | Dimensions | Maße **1220 x 540 mm > 1003 W**
1520 x 540 mm > 1258 W
1820 x 540 mm > 1505 W

> Sistema de enganche
 Sistema di aggancio
 Hooking system
 Système de fixation
 Befertigungssystem

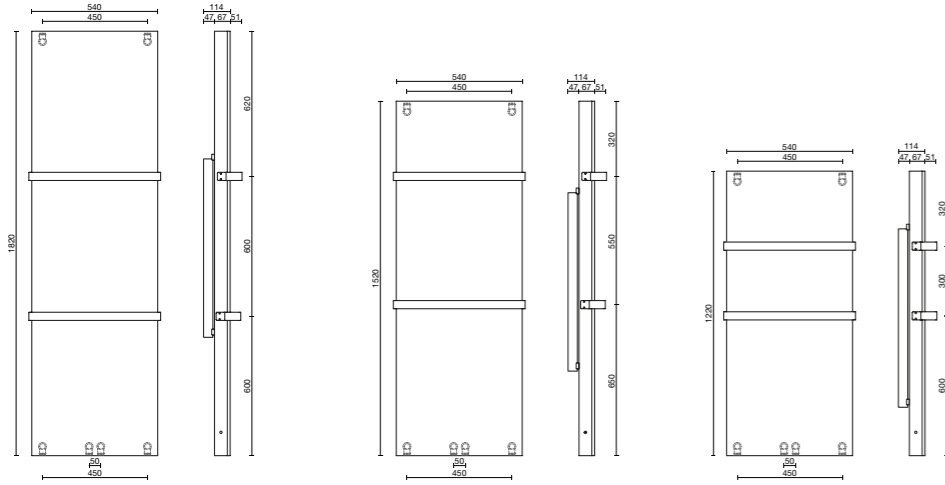

Texturas & Colores | Finiture & Colori | Textures & Colours | Textures & Couleurs | Strukturen & Farben

PIZARRA

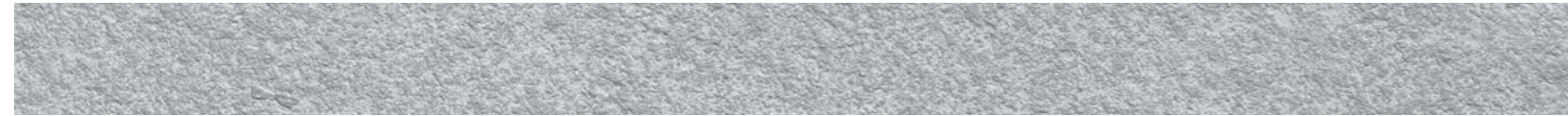

Colores Sólidos | Colori a tinta unita | Solid Colours | Couleurs Uniformes | Grundfarben



Colores Nature | Colori Nature | Nature Colours | Couleurs Nature | Patinierte Farben

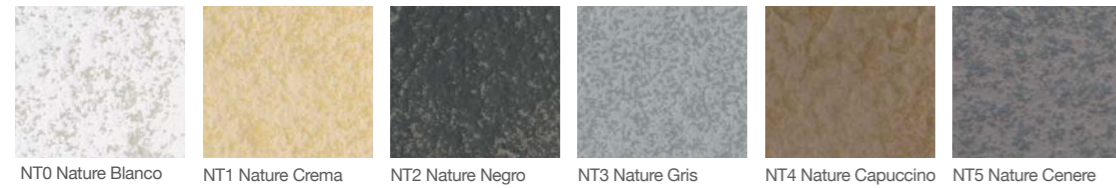

ENEZIA



Colores Sólidos | Colori a tinta unita | Solid Colours | Couleurs Uniformes | Grundfarben

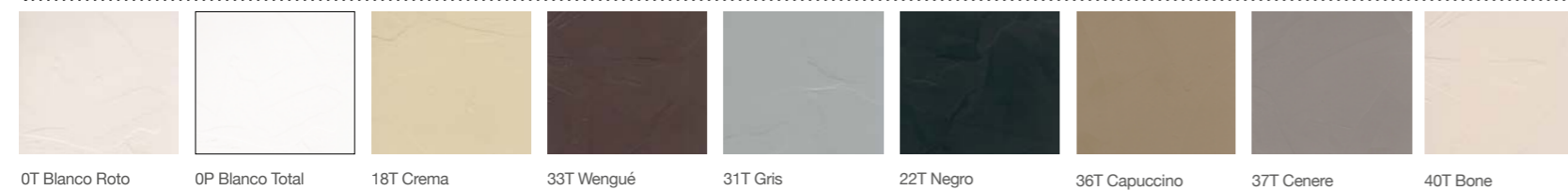

Texturas & Colores | Finiture & Colori | Textures & Colours | Textures & Couleurs | Strukturen & Farben

STUCCO

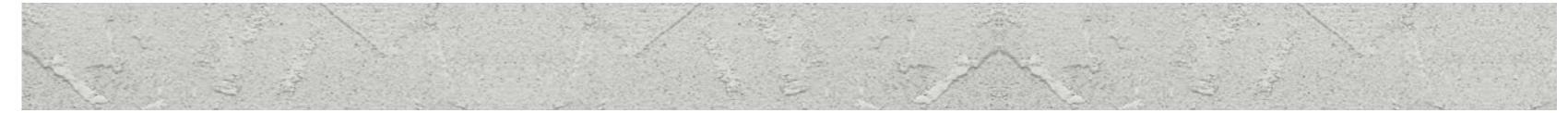

Colores Sólidos | Colori a tinta unita | Solid Colours | Couleurs Uniformes | Grundfarben



Colores Nature | Colori Nature | Nature Colours | Couleurs Nature | Patinierte Farben

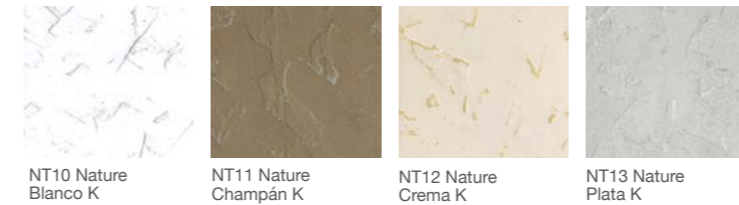

NEW

OAK



Colores Sólidos | Colori a tinta unita | Solid Colours | Couleurs Uniformes | Grundfarben



Colores Nature | Colori Nature | Nature Colours | Couleurs Nature | Patinierte Farben



LISO Colores Sólidos | Colori a tinta unita | Solid Colours | Couleurs Uniformes | Grundfarben

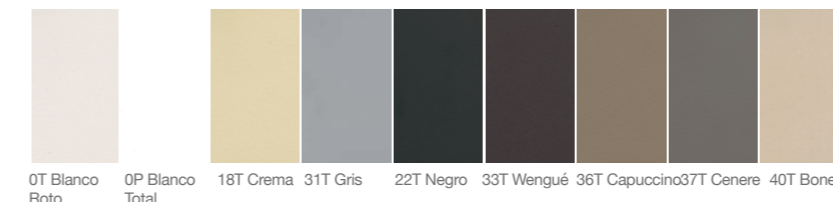

SACO Colores Sólidos | Colori a tinta unita | Solid Colours | Couleurs Uniformes | Grundfarben

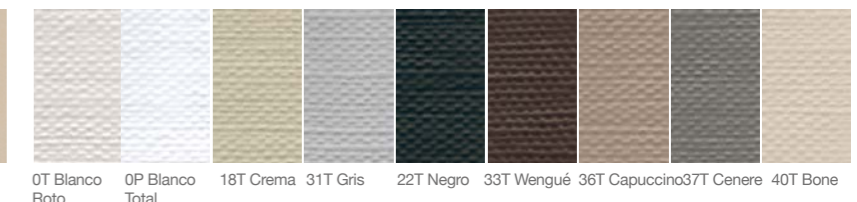

Radiadores
Radiator
Radiators
Radiateurs
Badheizkörper

Vulcano Electric

Control de temperatura digital y programable
Controllo della temperatura digitale e programmabile
With digital and programmable temperature control
Avec contrôle de température numérique et programmable
Mit digitaler und einstellbarer Temperaturanzeige



Ejemplo de combinación con panel Skin y platos de ducha
Esempio di combinazione con pannello Skin e piatto doccia
Example of combination with Skin panel and shower trays
Exemple de coordination avec panneau Skin et Receveurs de Douche
Beispiel einer Kombination mit Wandpaneel Skin und Duschboden

- en el hogar - In casa - In the home - Dans la maison - In anderen Wohnbereichen



Pizarra Nature Cenere



Pizarra Lamas Nature Blanco



Vulcano Electric

Información Técnica | Scheda tecnica | Technical Information | Informations Techniques | Technische Daten

Dimensiones | Dimensioni | Dimensions | Dimensions | Maße

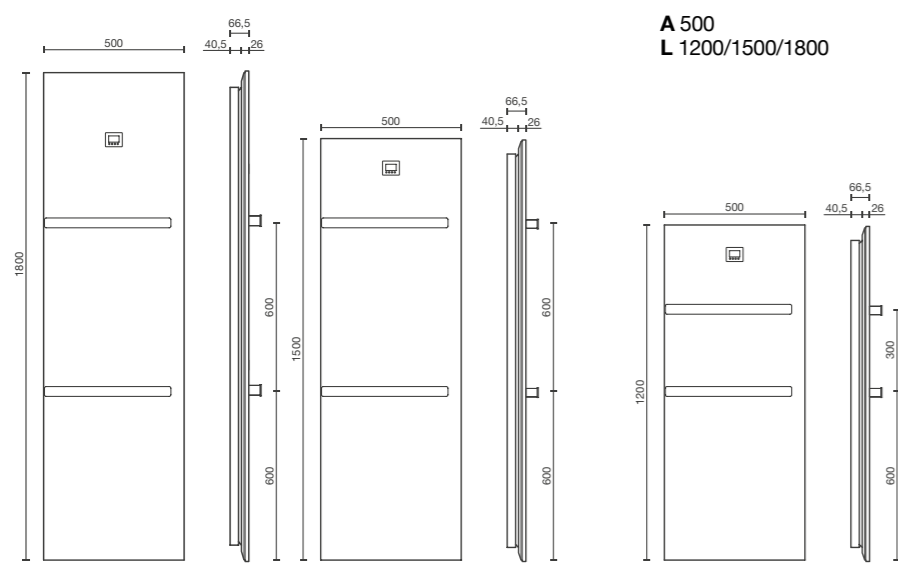

A 500
L 1200/1500/1800

> Sistema de enganche
Sistema di aggancio
Hooking system
Système de fixation
Befertigungssystem

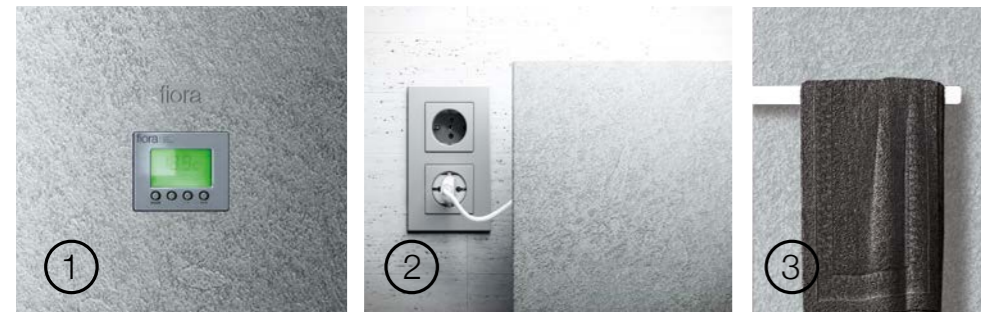

- 1. Detalle pantalla**
Particolare schermata
Screen detail
Détail écran
Display
- 2. Detalle enchufe**
Particolare attacco
Socket detail
Détail branchement
Detail Stecker
- 3. Detalle toallero**
Particolare portasciugamani
Towel holder detail
Détail porte-serviettes
Detail beheiztes Handtuch

Texturas & Colores | Finiture & Colori | Textures & Colours | Textures & Couleurs | Strukturen & Farben

PIZARRA

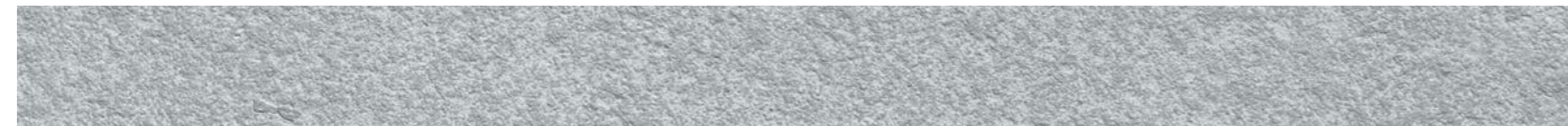

Colores Sólidos | Colori a tinta unita | Solid Colours | Couleurs Uniformes | Grundfarben



Colores Nature | Colori Nature | Nature Colours | Couleurs Nature | Patinierte Farben

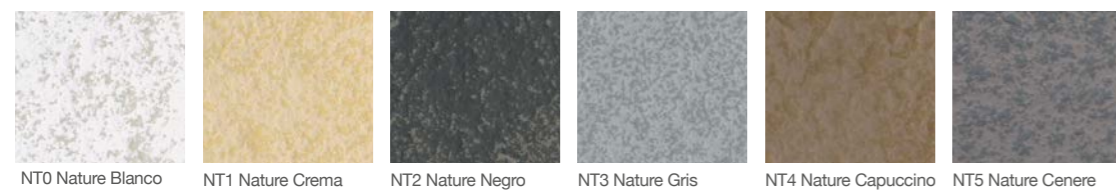

Texturas & Colores | Finiture & Colori | Textures & Colours | Textures & Couleurs | Strukturen & Farben

LAMAS

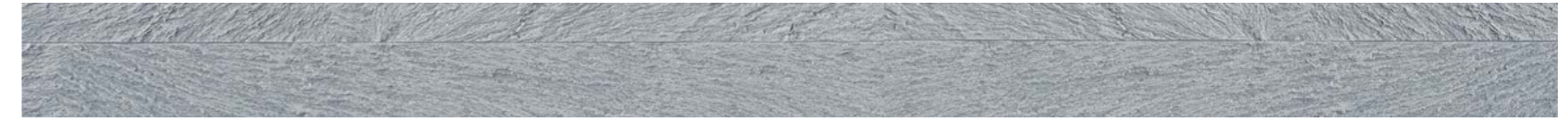

Colores Sólidos | Colori a tinta unita | Solid Colours | Couleurs Uniformes | Grundfarben



Colores Nature | Colori Nature | Nature Colours | Couleurs Nature | Patinierte Farben



SEMILLAS

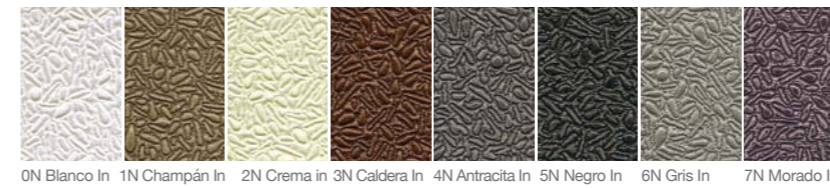

ROSAS

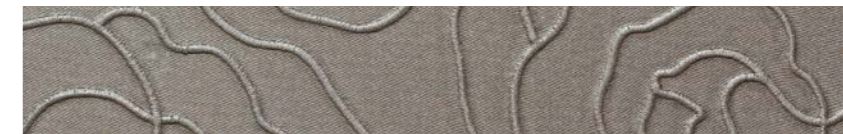

HILOS

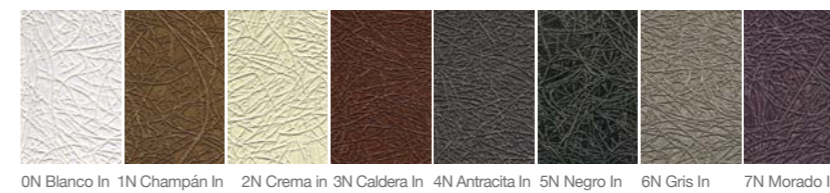
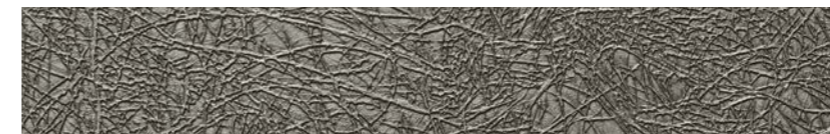

RUSTICA Colores Sólidos | A tinta unita | Solid Colours | Couleurs Uniformes | Grundfarben



Colores Nature | Colori Nature | Nature Colours | Couleurs Nature | Patinierte Farben

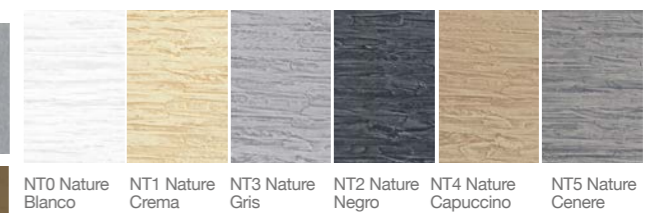

STUCCO

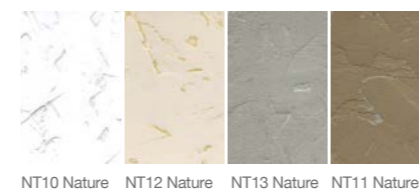

LISO

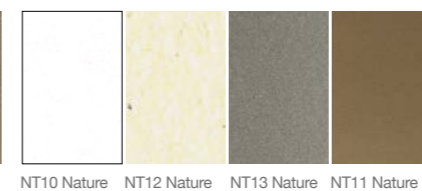
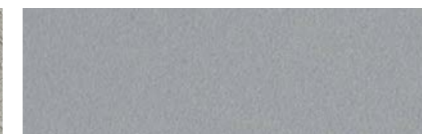

Radiadores
Radiator
Radiators
Radiateurs
Badheizkörper

Vulcano Hidro

Radiadores de agua para el baño y el hogar

Radiatori ad acqua per il bagno e la casa

Water radiators for the bathroom and the home

Radiateurs à eau pour la salle de bains et toute la maison

Badheizkörper mit Wasser fürs Badezimmer und andere Wohnbereiche



Radiador Hidro Baño 1800 Semillas Oro
Radiatore Hidro Bagno 1800 Semillas Oro
1800 Hidro Bathroom Radiator Semillas Oro
Radiateur Hidro Bain 1800 Semillas Oro
Badheizkörper Hidro Badezimmer 1800 Semillas Oro



Detalle toallero
Particolare portasciugamani
Towel holder detail
Détail porte-serviettes
Handtuchhalter



Radiador Hidro Baño 1800 Pizarra Blanca
Radiatore Hidro Bagno 1800 Pizarra Blanca
1800 Hidro Bathroom Radiator Pizarra Blanca
Radiateur Hidro Bain 1800 Pizarra Blanca
Badheizkörper Hidro Badezimmer 1800 Pizarra Blanca



Radiador Hidro Baño 1800 Lamas Gris
Radiatore Hidro Bagno 1800 Lamas Gris
1800 Hidro Bathroom Radiator Lamas Gris
Radiateur Hidro Bain 1800 Lamas Gris
Badheizkörper Hidro Badezimmer 1800 Lamas Gris



Vulcano Hidro

Información Técnica | Scheda tecnica | Technical Information | Informations Techniques | Technische Daten

Dimensiones | Dimensioni | Dimensions | Dimensions | Maße



A 500
L 1200/1500/1800

> 3 medidas disponibles con posibilidad de toallero
3 misure disponibili con possibilità di portasciugamani
3 sizes available with possibility of towel holder
3 dimensions disponibles avec possibilité de porte-serviettes
in 3 verschiedene Größen erhältlich

Texturas & Colores | Finiture & Colori | Textures & Colours | Textures & Couleurs | Strukturen & Farben

PIZARRA

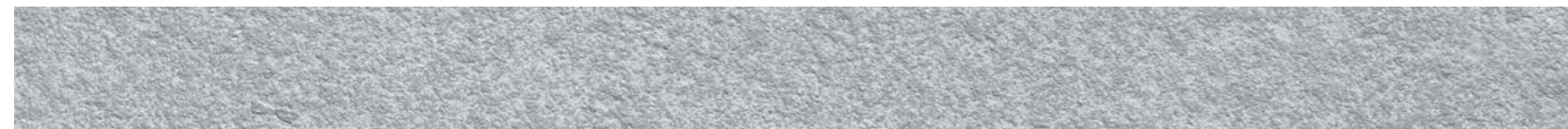

Colores Sólidos | Colori a tinta unita | Solid Colours | Couleurs Uniformes | Grundfarben



0T Blanco Roto 0P Blanco Total 18T Crema 33T Wengué 31T Gris 22T Negro 36T Capuccino 37T Cenere 40T Bone

Colores Nature | Colori Nature | Nature Colours | Couleurs Nature | Patinierte Farben



NT0 Nature Blanco NT1 Nature Crema NT2 Nature Negro NT3 Nature Gris NT4 Nature Capuccino NT5 Nature Cenere

Texturas & Colores | Finiture & Colori | Textures & Colours | Textures & Couleurs | Strukturen & Farben

LAMAS

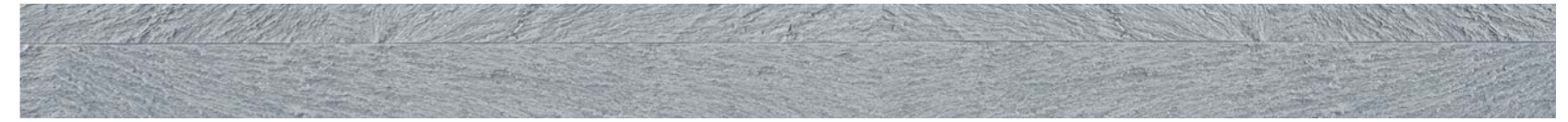

Colores Sólidos | Colori a tinta unita | Solid Colours | Couleurs Uniformes | Grundfarben



0T Blanco Roto 0P Blanco Total 18T Crema 33T Wengué 31T Gris 22T Negro 36T Capuccino 37T Cenere 40T Bone

Colores Nature | Colori Nature | Nature Colours | Couleurs Nature | Patinierte Farben

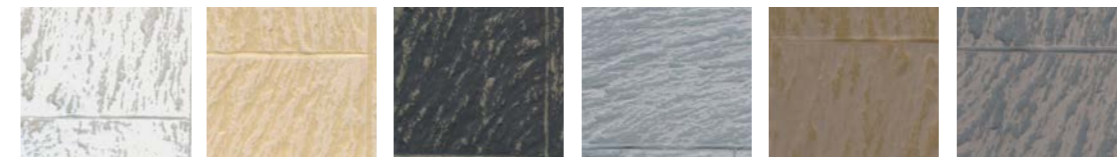

NT0 Nature Blanco NT1 Nature Crema NT2 Nature Negro NT3 Nature Gris NT4 Nature Capuccino NT5 Nature Cenere

SEMILLAS



0N Blanco IN 1N Champán IN 2N Crema IN 3N Caldera IN 5N Antracita IN 5N Negro IN 6N Gris IN 7N Morado IN

ROSAS



0N Blanco IN 1N Champán IN 2N Crema IN 3N Caldera IN 4N Antracita IN 5N Negro IN 6N Gris IN 7N Morado IN

HILOS



0N Blanco IN 1N Champán IN 2N Crema IN 3N Caldera IN 4N Antracita IN 5N Negro IN 6N Gris IN 7N Morado IN

Muebles
Mobili
Furniture
Meubles
Möbel

Making

Colección Modular
Collezione Modulare
Modular Collection
Collection Modulaire
Modulare Kollektion

OAK

Nueva textura
Nuova Finiture
New texture
Texture nouvelle
Nieuwe texturen



OAK NT13 Nature Plata K



OAK NT2 Nature Negro



OAK 40T Bone



OAK 0P Blanco Total



OAK 36T Capuccino



OAK 33T Wengué



Muebles
Mobili
Furniture
Meubles
Möbel

Making

Colección Modular
Collezione Modulare
Modular Collection
Collection Modulaire
Modulare Kollektion

OAK

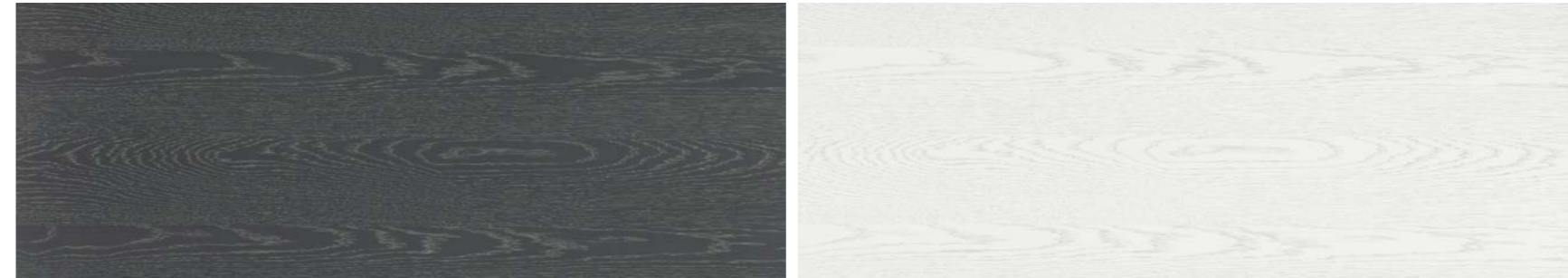
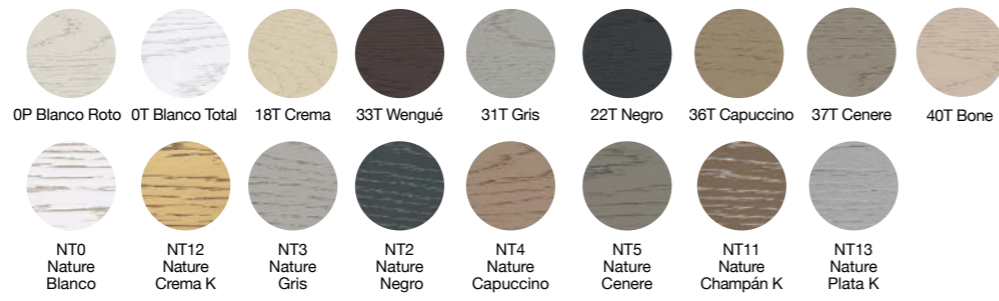

Muebles
Mobili
Furniture
Meubles
Möbel

Making

Colección Modular
Collezione Modulare
Modular Collection
Collection Modulaire
Modulare Kollektion

Without limits!



Muebles
Mobili
Furniture
Meubles
Möbel

Making



Muebles
Mobili
Furniture
Meubles
Möbel

Making



Consola integrada Pizarra Blanca
Console integrata Pizarra Blanca
Console with built-in Pizarra Blanca
Console intégrée Pizarra Blanca
Integrierte Waschtischplatte Pizarra Blanca



Consola integrada Pizarra Nature Blanca
Console integrata Pizarra Nature Blanca
Console with built-in Pizarra Nature Blanca
Console intégrée Pizarra Nature Blanca
Integrierte Waschtischplatte Pizarra Nature Blanca



Monobloc lavabo Gamma sobremesa
Monoblocco lavabo Gamma soprapiano
Monobloc Gamma table top wash basin
Monobloc vasque Gamma à poser
Monobloc Aufsatzwaschbecken Gamma



Muebles
Mobili
Furniture
Meubles
Möbel

Making



Coqueta 2 cajones + Mueble tocador con tapa. Pizarra Bone
Base 2 cassetti + Mobile cassettone con copertura. Pizarra Bone
2-Drawer vanity cabinet + Vanity cabinet with cover. Pizarra Bone
Coiffeuse 2 tiroirs + Meuble de rangement avec plateau. Pizarra Bone
Zusatzmodul mit 2 Schubladen + Unterschrank inkl. Abdeckung. Pizarra Bone



- Mini -



Lavabo suspendido Petit & Ovale
Lavabo sospeso Petit & Ovale
Wall hung Petit & Ovale wash basin
Vasque suspendue Petit & Ovale
Hängewaschbecken Petit & Ovale

Mueble suspendido 1 puerta. Liso Wengé
Mobile sospeso 1 anta. Liso Wengé
Wall hung vanity unit 1 door. Liso Wengé
Meuble suspendu 1 porte. Liso Wengé
Hängemöbel mit 1 Tür. Liso Wengé



Making

Información Técnica | Scheda tecnica | Technical Information | Informations Techniques | Technische Daten

Dimensiones & Sistemas de Colocación | Dimensioni & Sistemi di collocazione | Dimensions & Fitting Systems | Dimensions & Systèmes de Pose | Maße & Installationssysteme

3 ALTURAS
3 Altezza | 3 Heights | 3 Hauteurs | 3 Höhen

H 346 MM
H 576 MM
H 860 MM

2 Cajones | 2 Cassetti | 2 Drawers
2 Tiroirs | 2 Schubladen
3 Cajones | 3 Cassetti | 3 Drawers
3 Tiroirs | 3 Schubladen

2 SIST. DE COLOCACIÓN
2 Sist. Collocazione | 2 Fitting Systems | 2 Syst. Pose
2 Installationssysteme

Suspendido
Sospeso
Wall hung
Suspendu
Wandhängend

Con zócalo
Con zoccolo
With a base
Sur socle
Mit Sockel

6 ANCHURAS
6 Larghezze | 6 Widths | 6 Largeurs | 6 Breiten

Texturas & Colores | Finiture & Colori | Textures & Colours | Textures & Couleurs | Strukturen & Farben

OAK **NEW**

Colores Sólidos | Colori a tinta unita | Solid Colours | Couleurs Uniformes | Grundfarben

0T Blanco Roto 0P Blanco Total 18T Crema 33T Wengé 31T Gris 22T Negro 36T Capuccino 37T Cenere 40T Bone

Colores Nature | Colori Nature | Nature Colours | Couleurs Nature | Patinierte Farben

NT0 Nature Blanco NT12 Nature Crema K NT2 Nature Negro NT3 Nature Gris NT4 Nature Capuccino NT5 Nature Cenere NT11 Nature Champán K NT13 Nature Plata K

PIZARRA

Colores Sólidos | Colori a tinta unita | Solid Colours | Couleurs Uniformes | Grundfarben

0T Blanco Roto 0P Blanco Total 18T Crema 33T Wengé 31T Gris 22T Negro 36T Capuccino 37T Cenere 40T Bone

Colores Nature | Colori Nature | Nature Colours | Couleurs Nature | Patinierte Farben

NT0 Nature Blanco NT1 Nature Crema NT2 Nature Negro NT3 Nature Gris NT4 Nature Capuccino NT5 Nature Cenere

Columna 2 puertas | Colonna a due ante | **NEW**
Two-door column Colonne deux portes |
Hochschrank mit zwei Türen



Espejos | Specchi | Mirrors | Miroirs | Spiegel

NEW

Espejo-enmarcado repisa
Specchio incorniciato con mensola
Shelves framed mirror
Miroir-encadré étagère
Spiegel gerahmt mit Ablage

Enmarcado Textura
Bordato Finitura
Framed Texture
Encadré Texture
Gerahmt

Di Base
Di Base
Di Base
Di Base
Di Base

Espejo camerino
Specchio camerino
Mirror cabinet
Miroir loge
Spiegelschrank

Texturas & Colores | Finiture & Colori | Textures & Colours | Textures & Couleurs | Strukturen & Farben

LISO

Colores Sólidos | Colori a tinta unita | Solid Colours | Couleurs Uniformes | Grundfarben

0T Blanco Roto 0P Blanco Total 18T Crema 33T Wengué 31T Gris 22T Negro 36T Capuccino 37T Cenere 40T Bone

Colores IN | Colori IN | IN Colours | Couleurs IN | IN- Farben

0N Blanco IN 1N Champán In 2N Crema In 3N Caldera In 4N Antracita In 5N Negro In 6N Gris In 7N Morado In

STUCCO

Colores Sólidos | Colori a tinta unita | Solid Colours | Couleurs Uniformes | Grundfarben

0T Blanco Roto 0P Blanco Total 18T Crema 33T Wengué 31T Gris 22T Negro 36T Capuccino 37T Cenere 40T Bone

Colores Nature | Colori Nature | Nature Colours | Couleurs Nature | Patinierte Farben

NT10 Nature Blanco K NT11 Nature Champán K NT12 Nature Crema K NT13 Nature Plata K

Muebles
Mobili
Furniture
Meubles
Möbel

Intouch

Muebles, auxiliares y complementos conjuntados
Mobili, complementi e accessori abbinabili
Vanity units, auxiliary elements and matched accessories
Meubles, compléments et compléments assemblés
Möbel, Zusatzmodule und ganzheitliche Zusammenstellungen



Rosas Antracita
Rosas Antracita
Rosas Antracita
Rosas Antracita
Rosas Antracita



Mueble con zócalo 3 cajones. Rosas Champagne
Mobile con zoccolo 3 cassetti. Rosas Champagne
Floor standing vanity unit 3 drawers. Rosas Champagne
Meuble sur socle 3 tiroirs. Rosas Champagne
Möbel mit Sockel und 3 Schubladen. Rosas Champagne



Mueble suspendido 1 cajón curvo. Hilos Negro
Mobile sospeso 1 cassetto curvo. Hilos Negro
Wall hung curved vanity unit 1 drawer. Hilos Negro
Meuble suspendu 1 tiroir courbe. Hilos Negro
Hängemöbel mit 1 Schublade, oval. Hilos Negro



Intouch

Información Técnica | Scheda tecnica | Technical Information | Informations Techniques | Technische Daten

Dimensiones | DImensioni | Dimensions | Dimensions | Maße



**Muebles Rectos
(con zócalo, 2 cajones y 1 cajón)**
Mobili dritti
(con zoccolo, 2 cassetti e 1 cassetto)
Straight Furniture
(floor standing, 2 drawers and 1 drawer)
Meubles Droits
(avec socle, 2 tiroirs et 1 tiroir)
Eckige Möbel
(mit Sockel, 2 Schubladen und 1 Schublade)

**A DE 700 A 1200 MM
H 337 / 570 / 850 MM
P 480 MM**



**Muebles Curvos
(con zócalo, 2 cajones y 1 cajón)**
Mobili curvi
(con zoccolo, 2 cassetti e 1 cassetto)
Curved Furniture
(floor standing, 2 drawers and 1 drawer)
Meubles Courbes
(avec socle, 2 tiroirs et 1 tiroir)
Ovale Möbel
(mit Sockel, 2 Schubladen und 1 Schublade)

**A DE 700 A 1200 MM
H 337 / 570 / 850 MM
P 432 MM**



SUSPENDIDOS
SUSPENSO
WALL HUNG
SUSPENDUS
WANDHÄNGEND



CON ZÓCALO
CON ZOCCOLO
FLOOR STANDING
SUR SOCLE
MIT SOCKEL

Colgables y Columnas | Pensili e Colonne | Wall vanity units and High Cabinets | Éléments à suspendre et Colonnes | Hochschränke



Columnas con cajones
Colonne con cassetti
High cabinets with drawers
Colonnes à tiroirs
Hochschrank mit Schubladen

Colgables puertas
Pensili ante
High cabinets with doors
Éléments suspendus avec portes
Hochschranke mit Türen

Auxiliares con ruedas | Ausiliari con ruote | Auxiliary elements with wheels | Compléments avec roulettes | Solitärmöbel auf rollen



Rectos
Dritti
Straight
Droits
Eckig

Curvos
Curvi
Curved
Courbes
Oval

Baldas & Toalleros | Mensole & Portasciugamani | Shelves & Towel holders | Shelves & Towel holders | Ablage & Handtuchhalter



Baldas
Mensole
Shelves
Étagères
Ablage

Toalleros
Portasciugamani
Towel holders
Porte-serviettes
Handtuchhalter

Espejos | Specchi | Mirrors | Miroirs | Spiegel



Espejo camerino
Specchio camerino
Mirror cabinet
Miroir loge
Spiegelschrank

Espejo auxiliar de aumento
Specchio ingranditore supplementare
Auxiliary magnifying mirror
Miroir auxiliaire grossissant
Zusätzlicher Kosmetikspiegel

Espejo enmarcado textura
Specchio bordato con finiture
Textured framed mirror
Miroir encadré textur
Spiegel eingerahmt

Espejo moldura Liso
Specchio cornice Liso
Mirror with moulding Liso
Miroir moulure Liso
Spiegel Zierleiste

Espejo Teja textura
Specchio Teja finitura
Mirror Teja texture
Miroir texture Teja
Spiegel Teja Struktur

Encimeras y Lavabos | Top e Lavabis | Vanity tops and Wash basins | Encimeras y Lavabos | Plans et Vasques | Waschtische und Waschbecken



Encimera integrada recta
Top integrato dritto
Straight built-in vanity top
Plan intégré droit
Integrierter eckiger Waschtisch

Encimera integrada curva
Top integrato curvo
Curved built-in vanity top
Plan intégré courbe
Integrierter ovaler Waschtisch

Encimera sobremesa recta
Top soprapiano dritto
Straight tabletop vanity top
Plan à poser droit
Waschtischplatte eckig

Encimera bajoplano recta
Top sottopiano dritto
Straight undermount vanity top
Plan à encastrer droit
Waschtischplatte zum
Einsenken eckig

Encimera sobremesa curva
Top soprapiano curvo
Curved tabletop vanity top
Plan à poser courbe
Ovale Waschtischplatte

Lavabo ZETA
Lavabo ZETA
ZETA wash basin
Vasque ZETA
Waschbecken ZETA

Texturas & Colores | Finiture & Colori | Textures & Colours | Textures & Couleurs | Strukturen & Farben

LISO

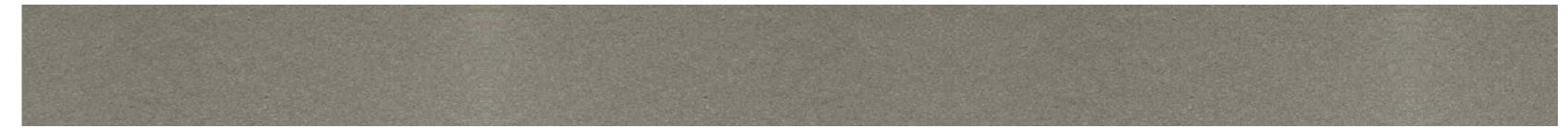

0N Blanco IN

2N Crema IN

1N Champán IN

6N Gris IN

4N Antracita IN

5N Negro IN

3N Caldera IN

7N Morado IN

ROSAS



0N Blanco IN

2N Crema IN

1N Champán IN

6N Gris IN

4N Antracita IN

5N Negro IN

3N Caldera IN

7N Morado IN

HILOS

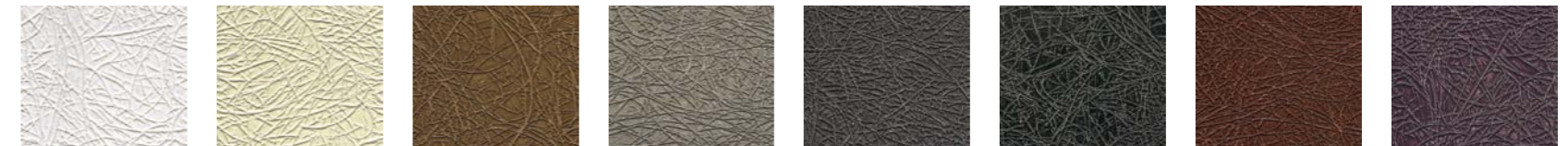

0N Blanco IN

2N Crema IN

1N Champán IN

6N Gris IN

4N Antracita IN

5N Negro IN

3N Caldera IN

7N Morado IN

SEMILLAS

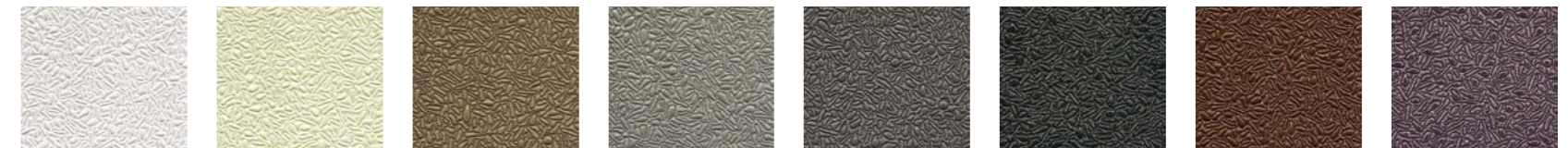
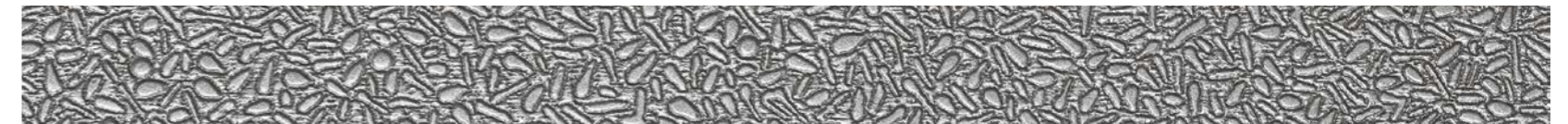

0N Blanco IN

2N Crema IN

1N Champán IN

6N Gris IN

4N Antracita IN

5N Negro IN

3N Caldera IN

7N Morado IN

Muebles
Mobili
Furniture
Meubles
Möbel

Vivaldi

Estilo clásico

Stile classico

Classical style

Style classique

Klassischer Stil

Encimera con textura Pizarra Blanca

Top soprapiano con finiture Pizarra Blanca

Tabletop with texture Pizarra Blanca

Plan à poser avec texture Pizarra Blanca

Waschtischplatte mit strukture Pizarra Blanca



Mueble 1 y 2 cajones. Texturas Flores y Ondas
Mobile 1 e 2 cassetti. Finiture Flores e Ondas
Vanity unit 1 and 2 drawers. Textures Flores and Ondas
Meuble 1 et 2 tiroirs. Textures Flores and Ondas
Möbel mit 1 und 2 Schubladen . Strukture Flores and Ondas



Vivaldi

Información Técnica | Scheda tecnica | Technical Information | Informations Techniques | Technische Daten

Dimensiones | Dimensioni | Dimensions | Dimensions | Maße



H 880 MM

Mueble 1 Cajón
Mobile 1 cassetto
Vanity unit 1 Drawer
Meuble 1 tiroir
Möbel mit 1 Schublade
L 1000/1200
P 510
H 880



H 880 MM

Mueble 2 Cajones
Mobile 2 cassetti
Vanity unit 2 Drawers
Meuble 2 tiroirs
Möbel mit 2 Schubladen
L 1000/1200
P 510
H 880

L 1000/1200 MM

L 1000/1200 MM

Columnas con puerta | Colonne con anta High cabinets with door | Colonne avec porte | Hochschränke mit Tür



L 500
P 350
H 1290



L 500
P 350
H 1290

Columna con vitrina | Colonna con vetrina | High cabinet with display vanity unit | Colonne avec vitrine | Hochschrank mit Vitrine vitrine

Espejos | Specchi | Mirrors | Miroirs | Spiegel



Espejo enmarcado inglete horizontal
Specchio bordato con taglio orizzontale
Horizontal mitred joint mirror
Miroir encadré biseau horizontal
Mit horizontaler Gehrung eingefasster Spiegel

L 900/1100
P 50
H 600



Espejo enmarcado inglete vertical
Specchio bordato con taglio verticale
Vertical mitred joint mirror
Miroir encadré biseau vertical
Mit vertikaler Gehrung eingefasster Spiegel

L 600
P 50
H 900

Encimeras y Lavabos | Top e lavabi | Vanity tops and Wash basins | Plans et Vasques | Waschtisch

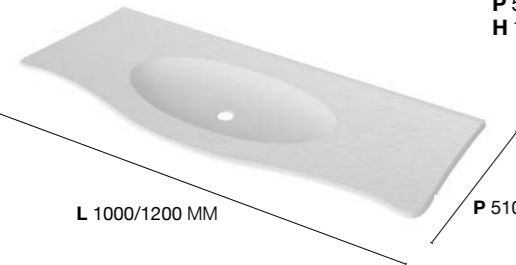

L 1000/1200
P 510
H 12

L 1000/1200 MM

P 510 MM

Texturas & Colores | Finiture & Colori | Textures & Colours | Textures & Couleurs | Strukturen & Farben

FLORES



F3 Blanco

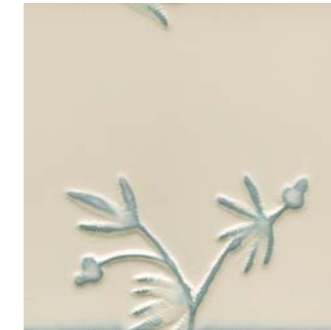

F2 Crema



F8 Plata



F5 Negro

ONDAS



A3 Blanco

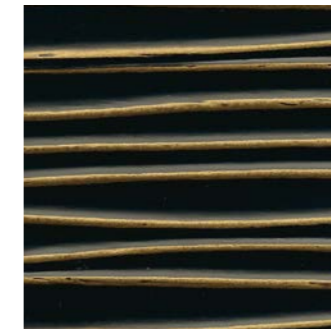

A7 Oro



A8 Plata

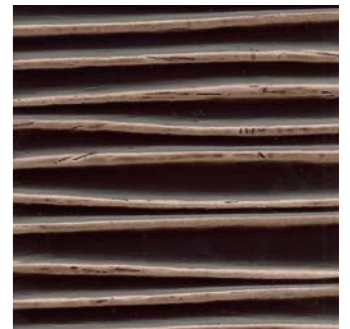

A1 Marrón

Lavabos&Consolas
Lavabi & Console
Wash basins & Consoles
Vasques & Consoles
Handwaschbecken & Waschtische

Fontana

Consolas Rectas, Consolas Curvas y Lavabos Sobremesa
Console dritte, Curve, Lavabi soprapiano
Straight Curves Consoles, Table top wash basins
Consoles Droites, Courbes, Vasques à poser
Eckige, Ovale Waschtische, Aufsatzwaschbecken



Lavabo ALFA Liso Negro
Lavabo ALFA liso Negro
ALFA wash basin Liso Negro
Vasque ALFA Liso Negro
Aufsatzwaschbecken ALFA Liso Negro



Lavabo STONE Pizarra Negro
Lavabo STONE Pizarra Negro
STONE wash basin Pizarra Negro
Vasque STONE Pizarra Negro
Handwaschbecken STONE Pizarra Negro



Lavabo KAPPA Liso Blanco
Lavabo KAPPA Liso Blanco
KAPPA wash basin Liso Blanco
Vasque KAPPA Liso Blanco
Handwaschbecken KAPPA Liso Blanco



Consola curva con lavabo sobremesa OMICRON
Console curva con lavabo soprapiano OMICRON
Curved console with OMICRON tabletop wash basin
Console courbe avec vasque à poser OMICRON
Ovaler Waschtisch mit Aufsatzwaschbecken OMICRON



Fontana

Información Técnica | Scheda tecnica | Technical Information | Informations Techniques | Technische Daten

Tipos de Lavabos & Encimeras | Tipi di lavabi & Top | Types of Wash basins & Vanity tops | Types de Vasques & Plans | Verschiedene Waschtische

CONSOLAS RECTAS
CONSOLE DRITTE
STRAIGHT CONSOLES
CONSOLES DROITES
ECKIGER WASCHTISCHE



DE 700 A 2000 MM
> Pozas centradas, desplazadas y dobles.
> Con posibilidad de toallero integrado.
DE 700 A 2000 MM
> Vaschette centrate, decentrate e doppie.
> Con possibilità di portasciugamano integrato.
DE 700 A 2000 MM
> Centred, offset and double drain holes.
> Possibility of built-in towel holder.
DE 700 A 2000 MM
> Vasques centrées, décalées et doubles.
> Avec possibilité de porte-serviettes intégré
VON 700 BIS 2 000 MM
> Zentriert, versetzt und in doppelter Ausführung.
> Integrierter Handtuchhalter möglich

CONSOLAS CURVAS
CONSOLE CURVE
CURVED CONSOLES
CONSOLES COURBES
OVALE WASCHTISCHE



910 / 1010 / 1210 MM
Medidas disponibles
910 / 1010 / 1210 MM
Misure disponibili
910 / 1010 / 1210 MM
Measurements available
910 / 1010 / 1210 MM
Mesures disponibles
910 / 1010 / 1210 MM
Erhältliche Abmessungen

LAVABOS SOBREMESA
LAVABI SOPRAPIANO
TABLE TOP Wash basins
VASQUES À POSER
AUFSATZWASCHBECKEN



10 MODELOS
> Diversidad de medidas
> Formas varias: cuadrado, ovalado, etc.
10 MODELLI
> Diverse misure
> Forme varie: quadrata, ovale ecc...
10 MODELS
> Variety of sizes
> Several shapes: square, oval etc.
10 MODÈLES
> Choix de dimensions
> Formes variées : carrées, ovales, etc.
10 MODELLE
> Verschiedene Maße
> Verschiedene Formen: quadratisch, gerundet, etc.

Ejemplos de Consolas | Esempi di console | Examples of Consoles | Exemples de Consoles | Beispiele für Konsolen



Consola recta para lavabo bajo plano
Console dritta per lavabo sottopiano
Straight console for undermount wash basin
Console droite pour vasque à encastrer
Eckiger Waschtisch für Waschbecken zum Einsetzen

Consola recta lavabo sobremesa
Console dritta soprapiano
Straight console for tabletop wash basin
Console droite pour vasque à poser
Eckiger Waschtisch mit integriertem Waschbecken

Consola curva para lavabo sobremesa
Console dritta soprapiano
Curved console for tabletop wash basin
Console courbe pour vasque à poser
Ovaler Waschtischplatte für Aufsatzwaschbecken

Consola recta lavabo integrado desplazado
Console dritta lavabo integrato decentrato
Straight console built-in offset wash basin
Console droite vasque intégrée décalée
Eckiger Waschtisch mit integriertem, versetztem Waschbecken

Consola recta lavabo integrado
Console dritta lavabo integrato
Straight console built-in wash basin
Console droite vasque intégrée
Eckiger Waschtisch mit integriertem Waschbecken

Ejemplos de Lavabos | Esempi di lavabi | Examples of Wash basins | Exemples de Vasques | Beispiele für Handwaschbecken



Lavabo STONE
Lavabo STONE
STONE wash basin
Vasque STONE
Aufsatzwaschbecken STONE

Lavabo KAPPA
Lavabo KAPPA
KAPPA wash basin
Vasque KAPPA
Aufsatzwaschbecken KAPPA

LavaboOMICRON
LavaboOMICRON
OMICRON wash basin
VasqueOMICRON
AufsatzwaschbeckenOMICRON

Lavabo SIGMA
Lavabo SIGMA
SIGMA wash basin
Vasque SIGMA
Aufsatzwaschbecken SIGMA

Lavabo GAMMA
Lavabo GAMMA
GAMMA wash basin
Vasque GAMMA
Aufsatzwaschbecken GAMMA

Texturas & Colores | Finiture & Colori | Textures & Colours | Textures & Couleurs | Strukturen & Farben

PIZARRA

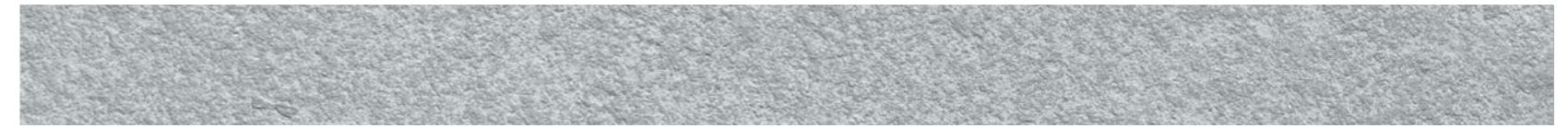

Colores Sólidos | Colori a tinta unita | Solid Colours | Couleurs Uniformes | Grundfarben

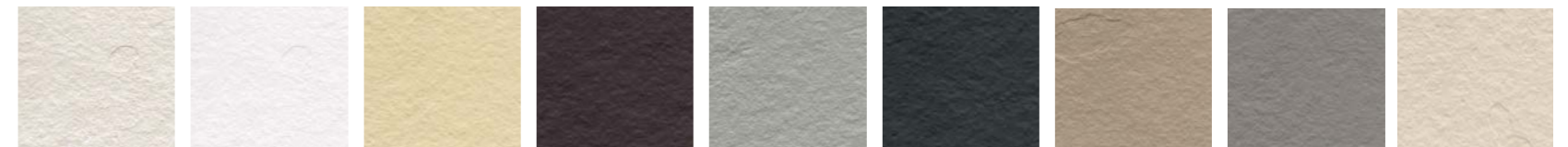

0T Blanco Roto 0P Blanco Total 18T Crema 33T Wengué 31T Gris 22T Negro 36T Capuccino 37T Cenere 40T Bone

Colores Nature | Colori Nature | Nature Colours | Couleurs Nature | Patinierte Farben

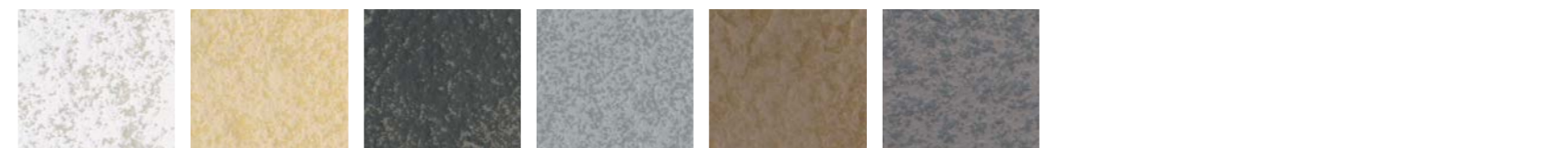

NT0 Nature Blanco NT1 Nature Crema NT2 Nature Negro NT3 Nature Gris NT4 Nature Capuccino NT5 Nature Cenere

LISO



0T Blanco Roto 0P Blanco Total 18T Crema 33T Wengué 31T Gris 22T Negro 36T Capuccino 37T Cenere 40T Bone

STUCCO

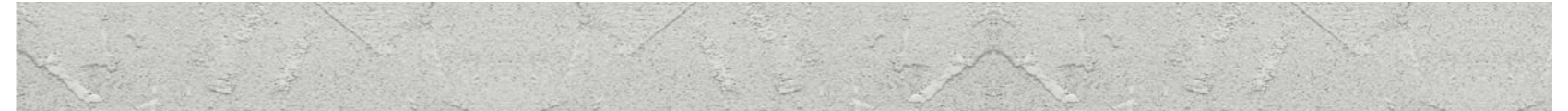

Colores Sólidos | Colori a tinta unita | Solid Colours | Couleurs Uniformes | Grundfarben



0T Blanco Roto 0P Blanco Total 18T Crema 33T Wengué 31T Gris 22T Negro 36T Capuccino 37T Cenere 40T Bone

Colores Nature | Colori Nature | Nature Colours | Couleurs Nature | Patinierte Farben



NT10 Nature Blanco K NT11 Nature Champán K NT12 Nature Crema K NT13 Nature Plata K

www.fiora.es

